



**PORTFOLIO**

**ART & GRAPHIC**

**AMIR TALACHIAN**



**PRODUCTS | GRAPHICS**  
DESIGN



# ETORA

*wall art project*

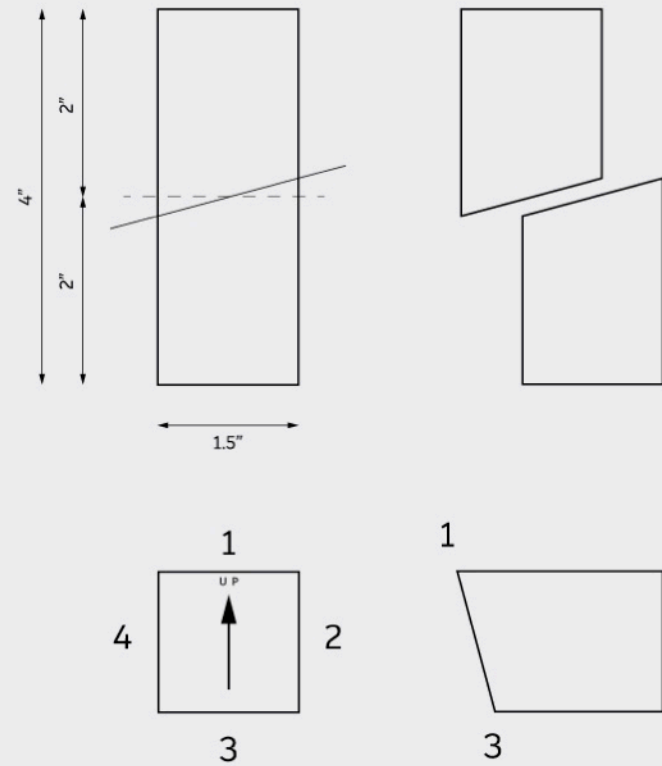
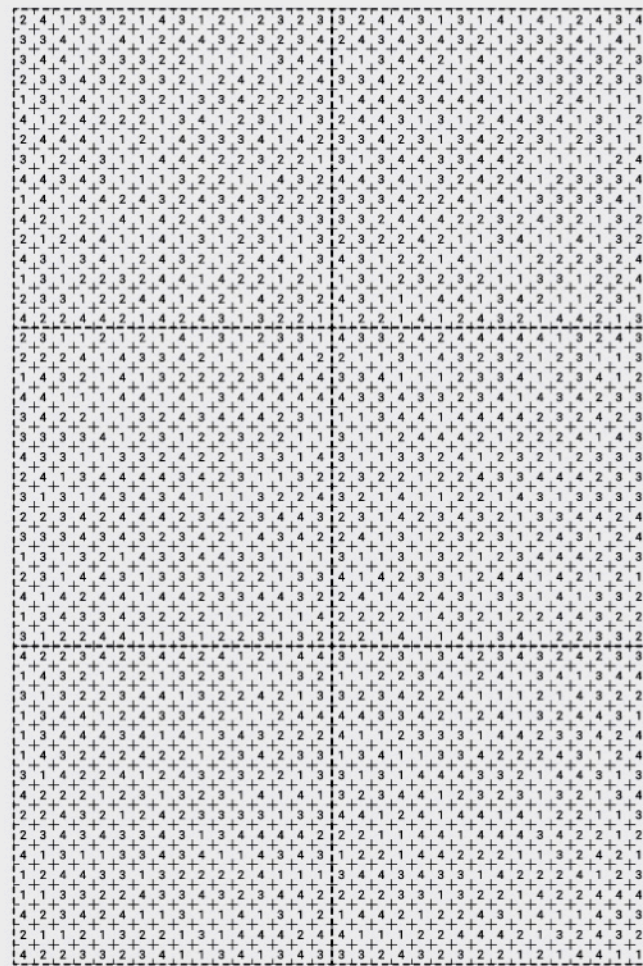
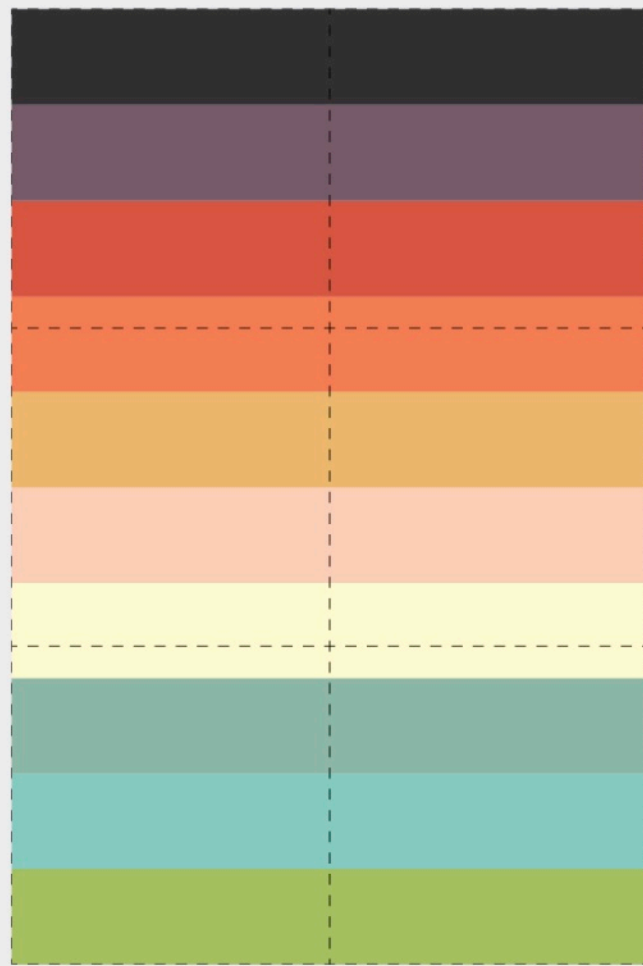

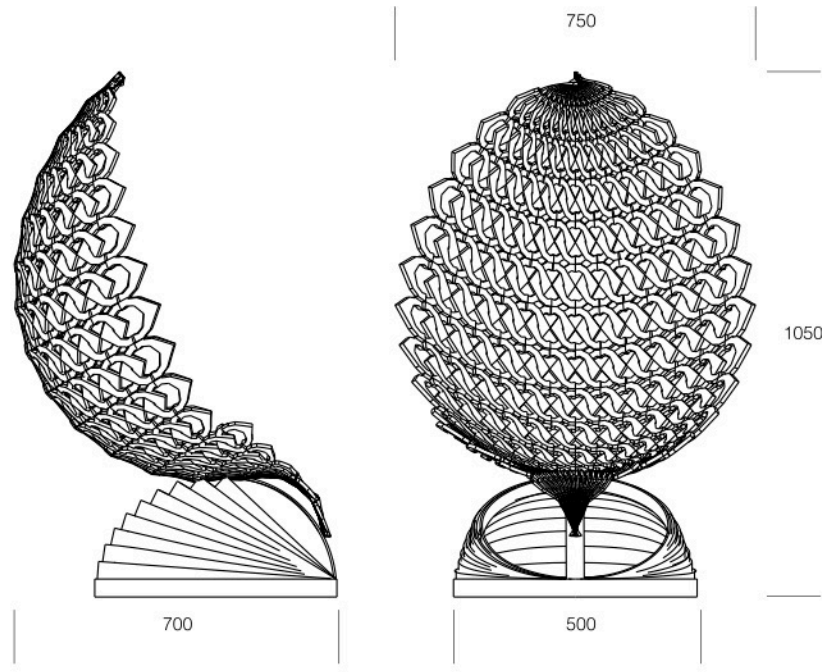
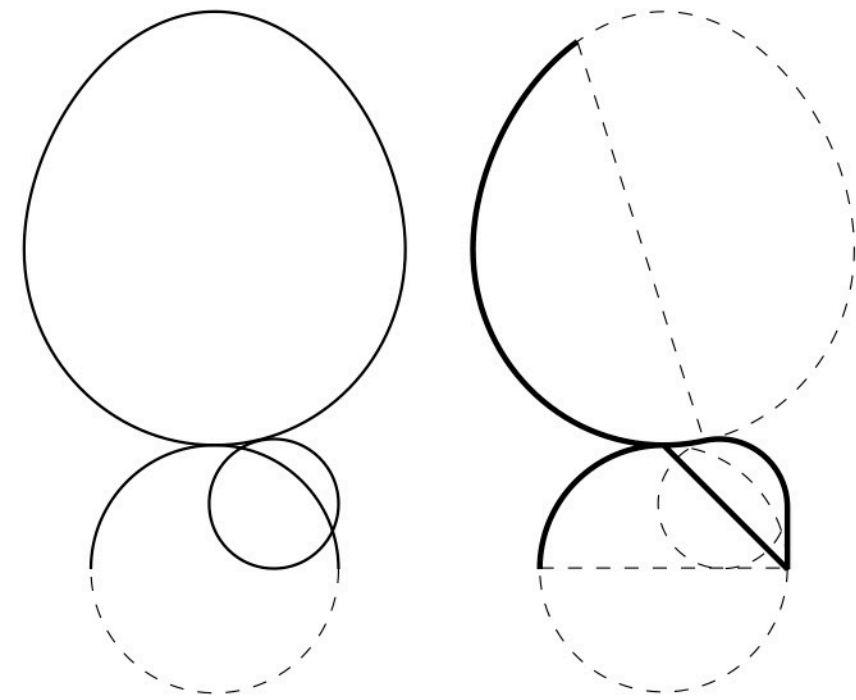

Material: Leather and Steel

 no.5  
CHAIR  
LEATHER

WHO EVER SAID THAT  
**PLEASURE WASN'T  
FUNCTIONAL?**

-CHARLES EAMES

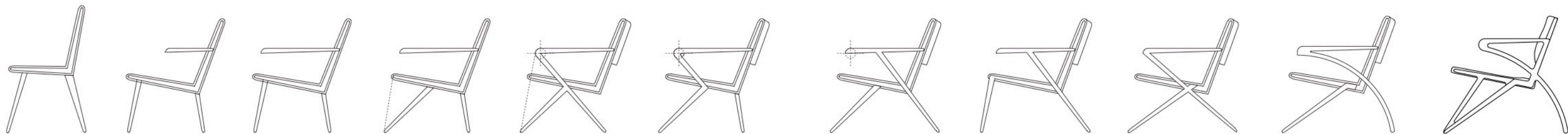
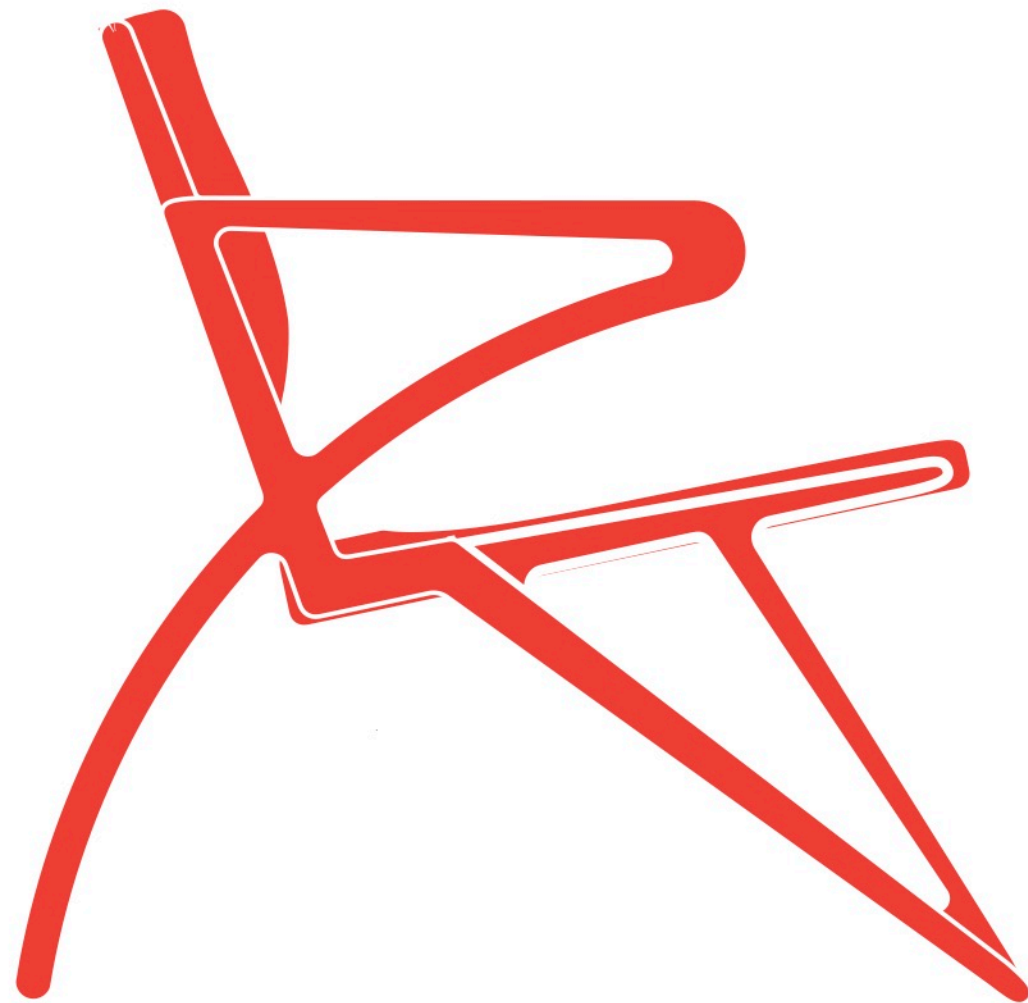

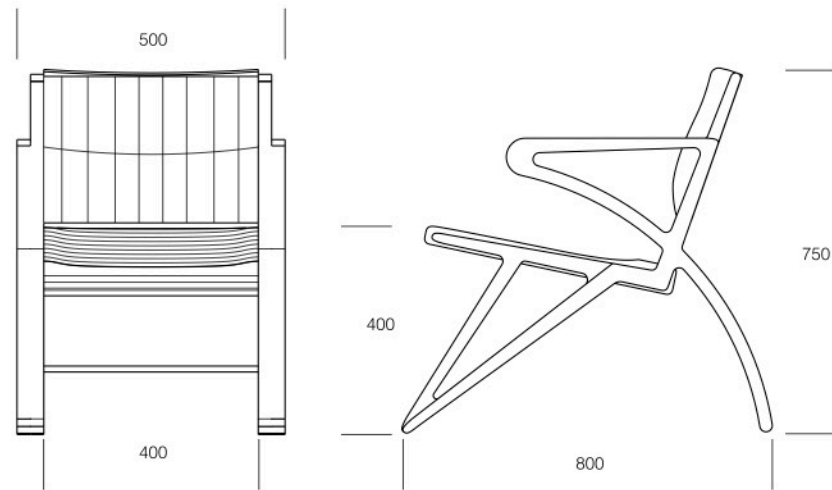
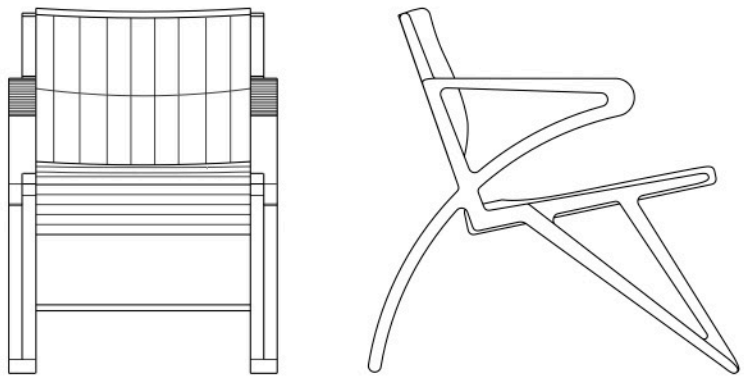

**A** beta  
chair

Material: Plywood

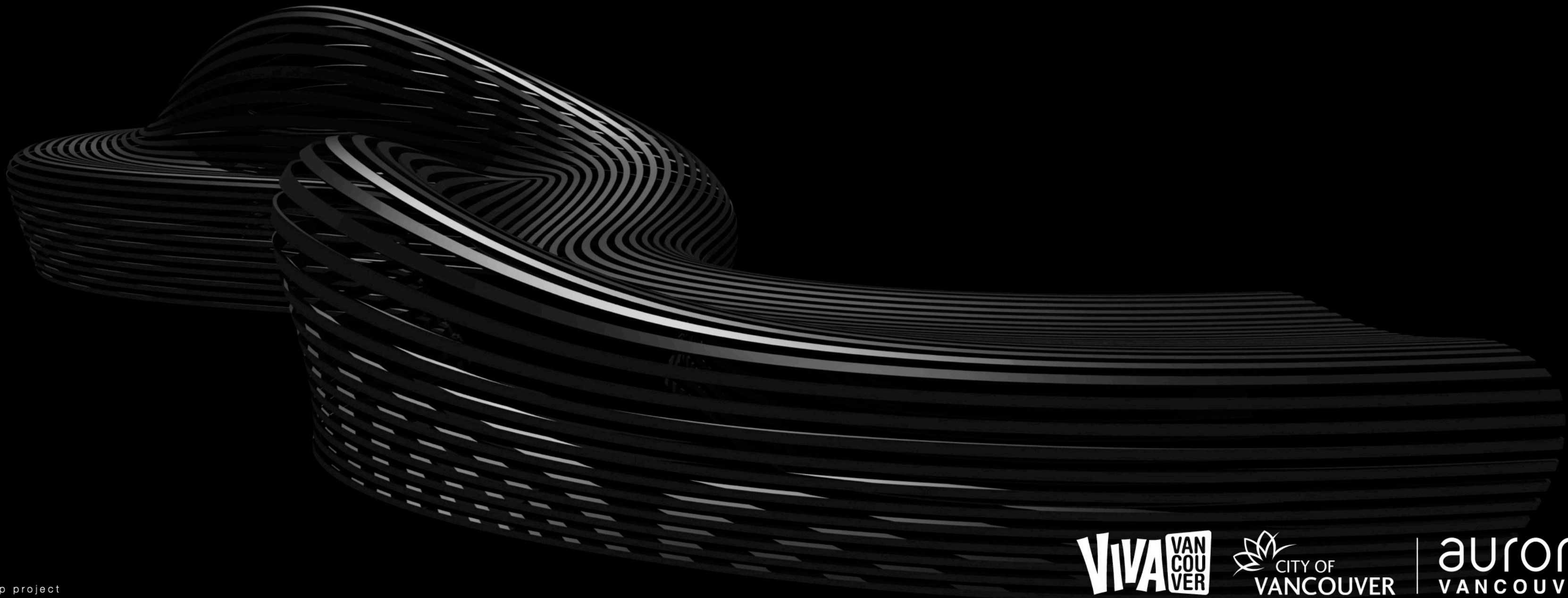

group project  
Designed 2015

**VIVA** VAN  
COU  
VER

 CITY OF  
VANCOUVER

| **aurora**  
VANCOUVER

Unit A:  
3x

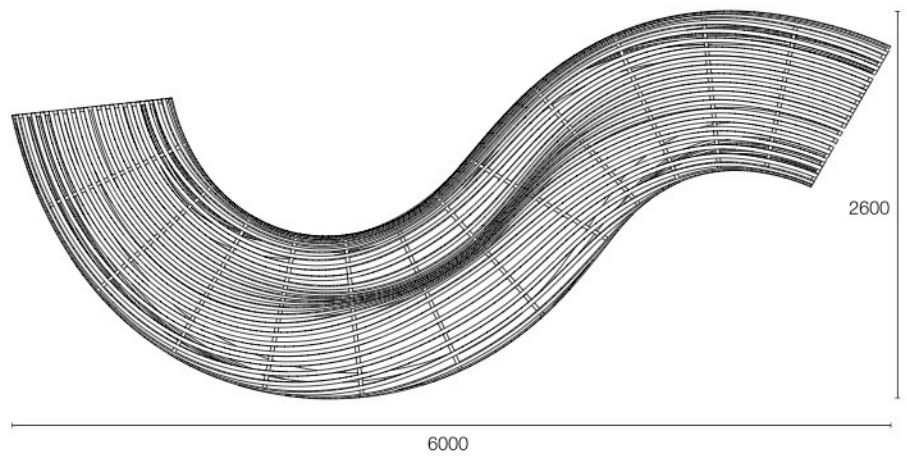

+

Unit B:  
3x

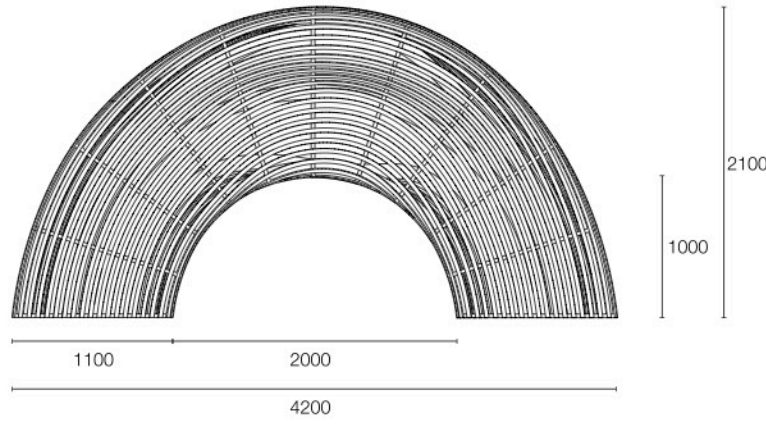

1200  
500

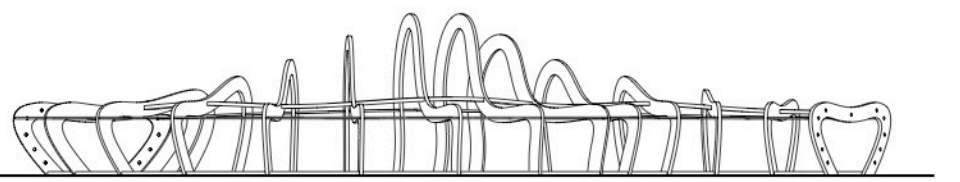
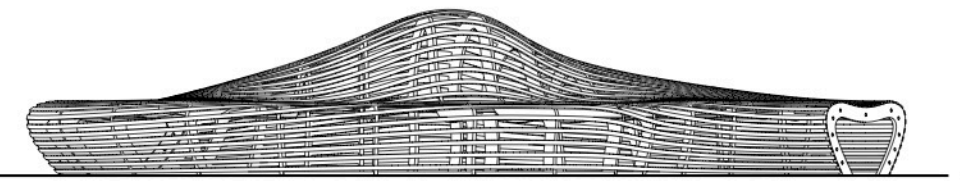
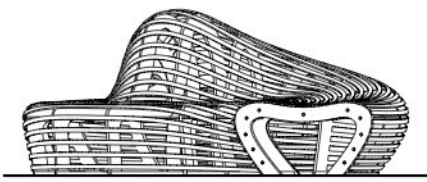

800

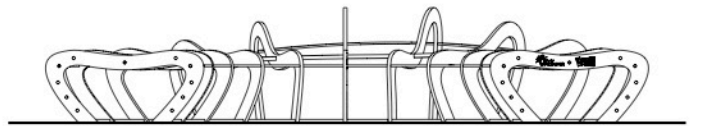
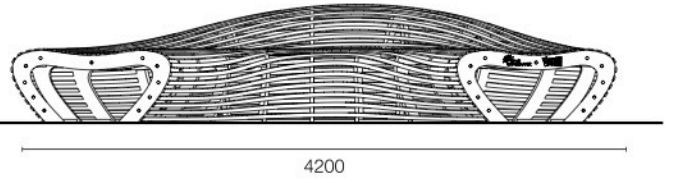
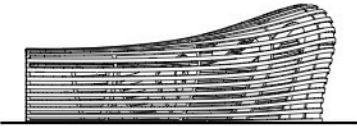











# CARBON CYCLE: WOOD PRODUCTS & SUSTAINABLE FORESTRY

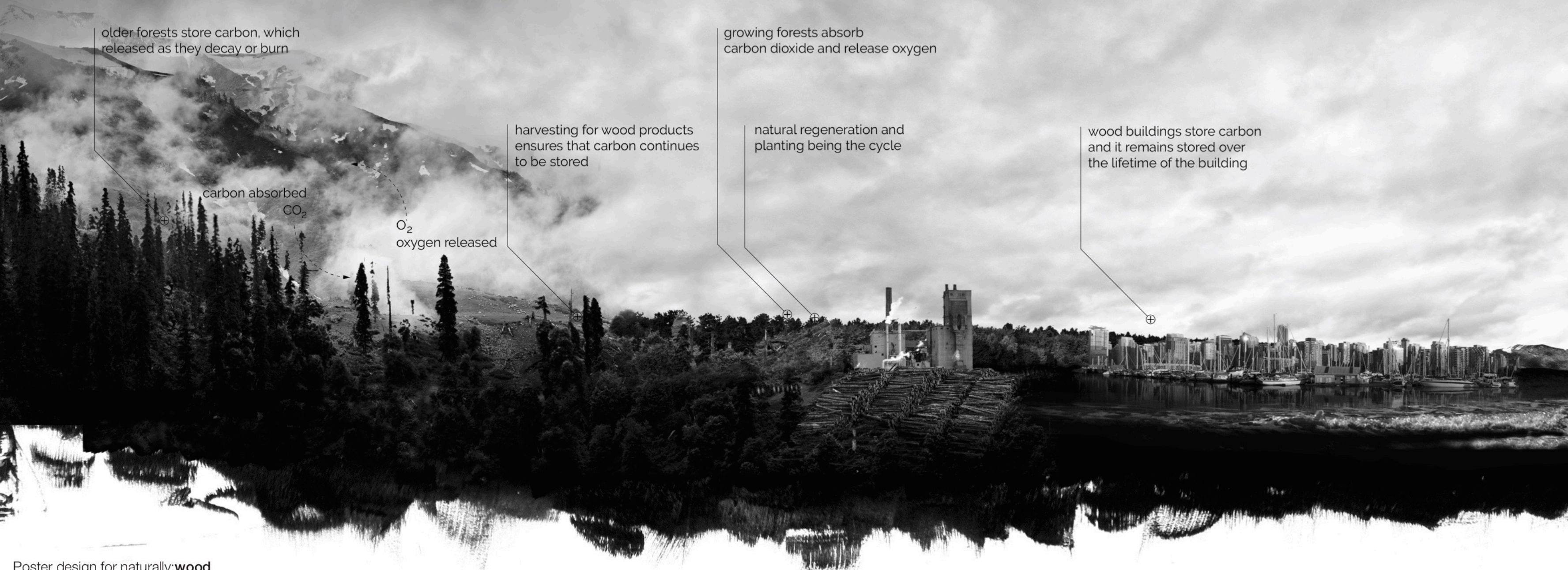

older forests store carbon, which released as they decay or burn

growing forests absorb carbon dioxide and release oxygen

harvesting for wood products ensures that carbon continues to be stored

natural regeneration and planting being the cycle

wood buildings store carbon and it remains stored over the lifetime of the building

carbon absorbed  
 $\text{CO}_2$

$\text{O}_2$   
oxygen released

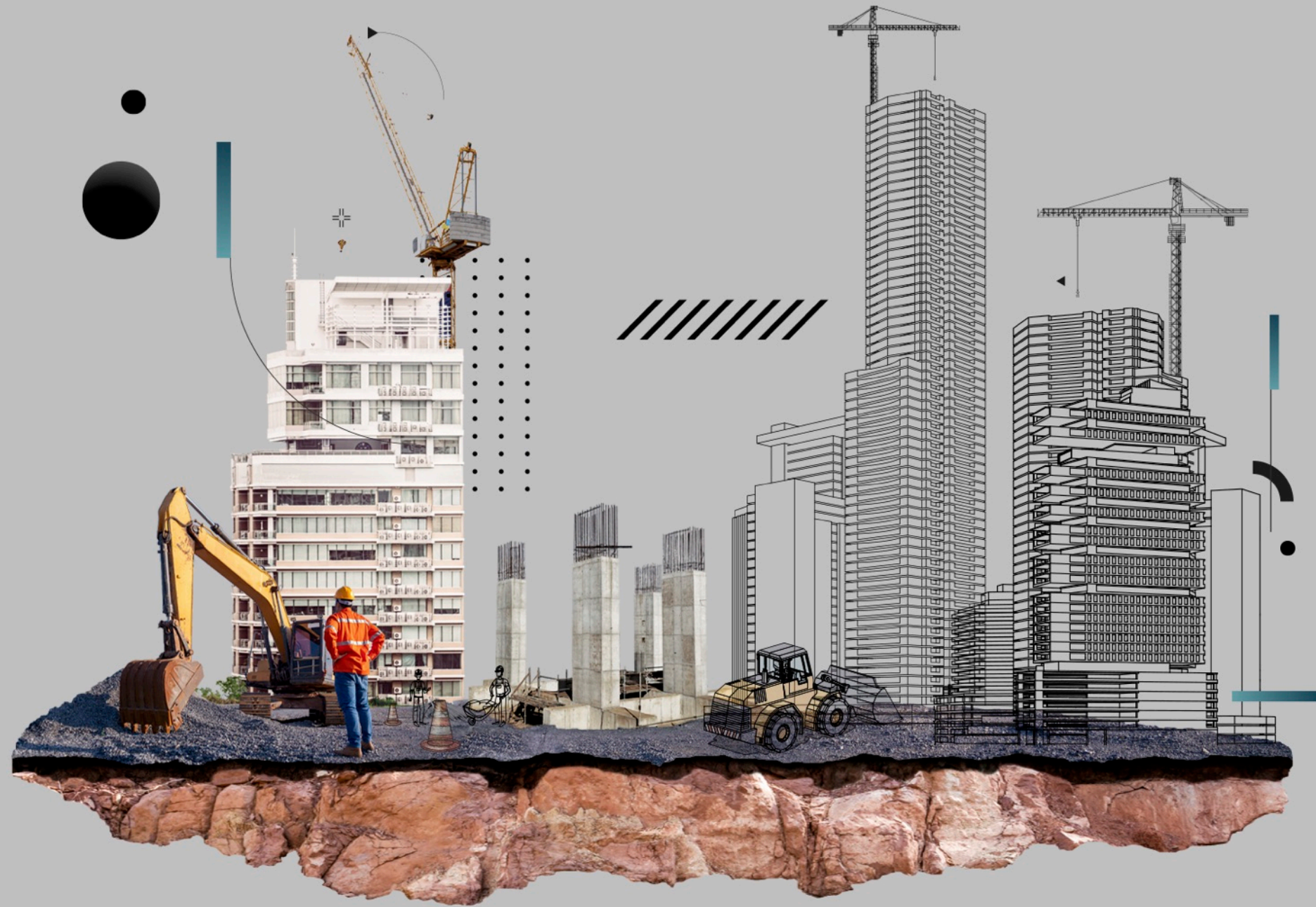



# SERVBOT SITE ADVISOR



MOVEMENT

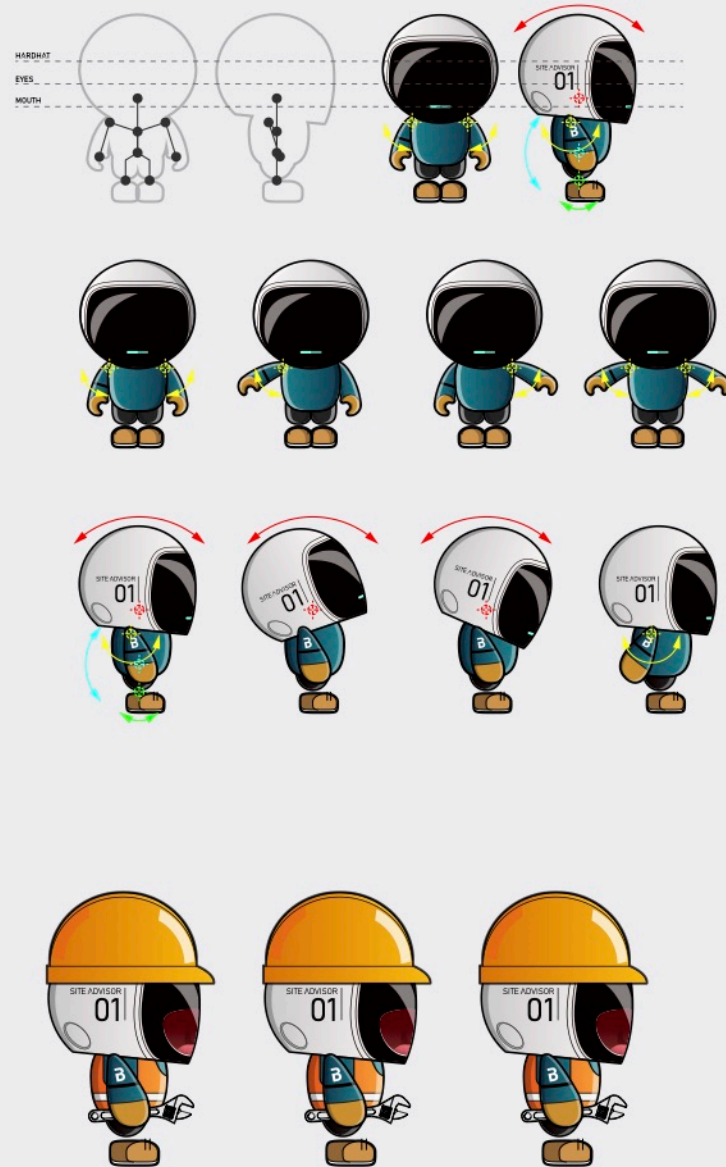

HANDS

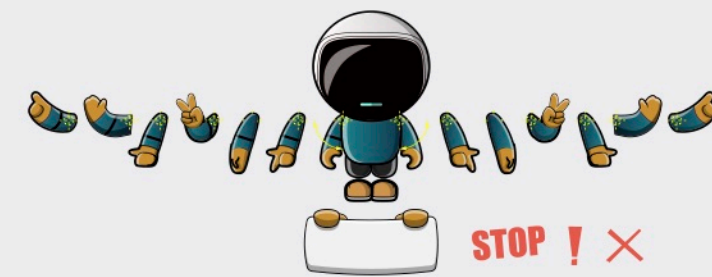

SCREEN SIGNS DISPLAY





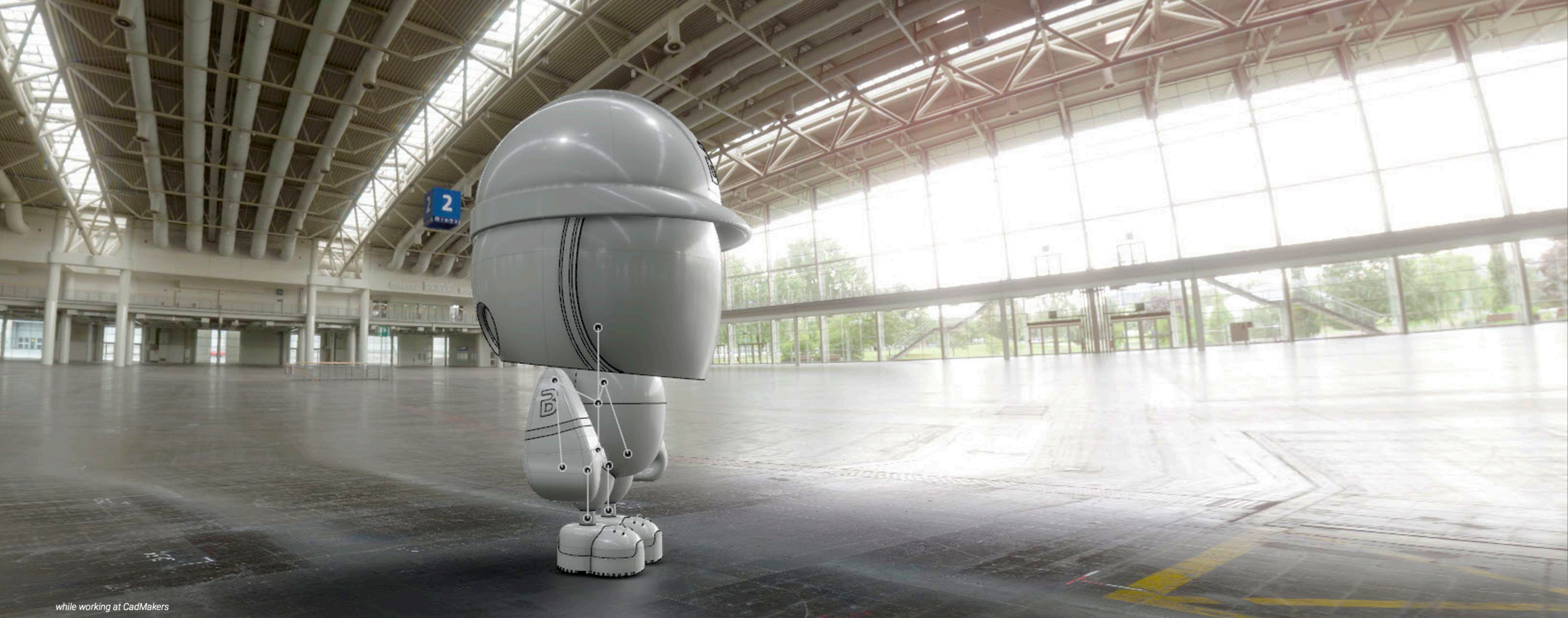



Welcome

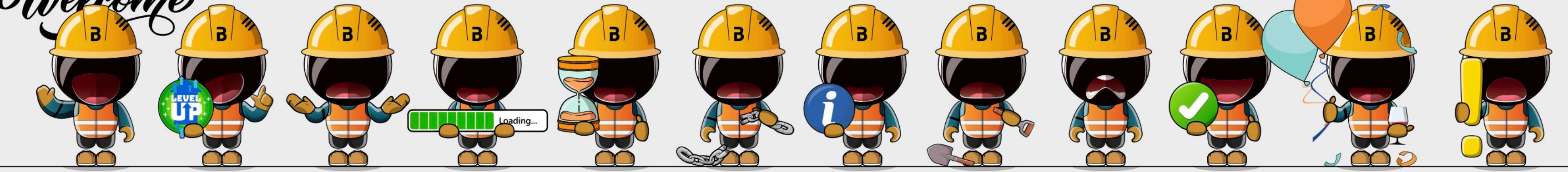

I AM YOUR FATHER!



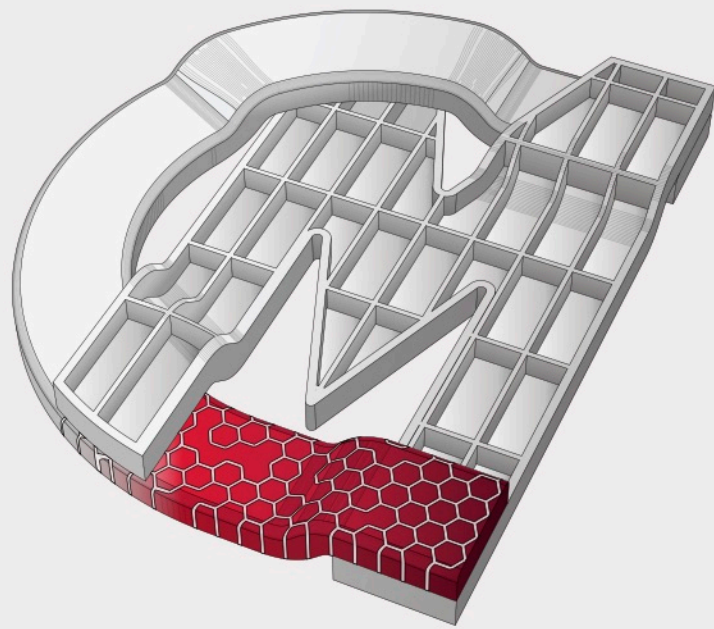

-service

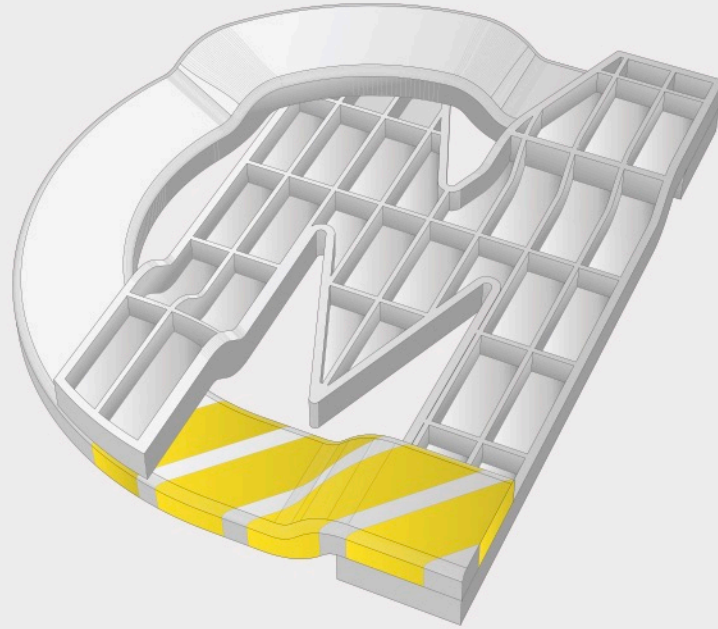

-manufacturing

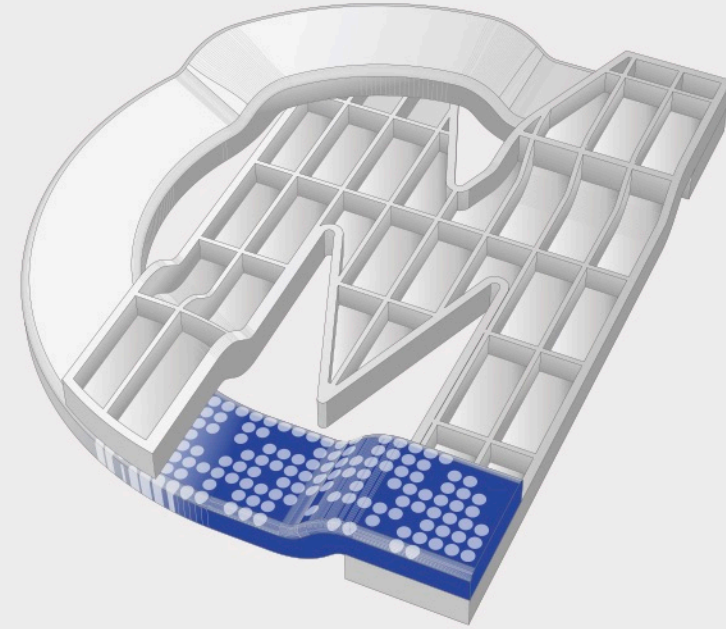

-software



-cmCore



-cmKnowledge



-cmProject  
Manager



-cmThreads



-cmExe

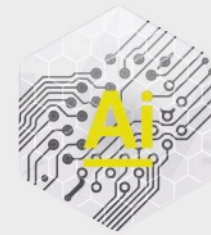

-cmAssist



-cmShop



-cmBuilder

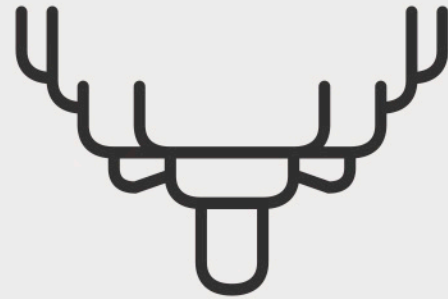

renovo

GINO



OROTECH

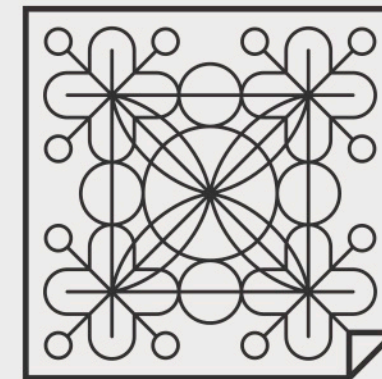

RENOWALL  
WALLPAPER



DELWAN  
CERAMICS



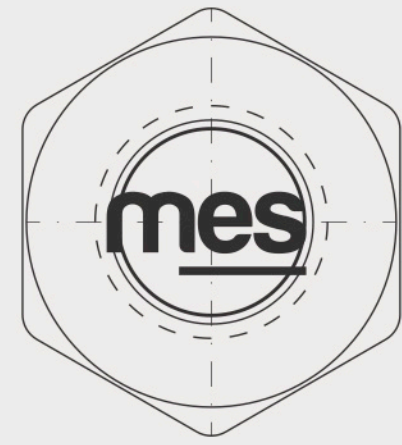
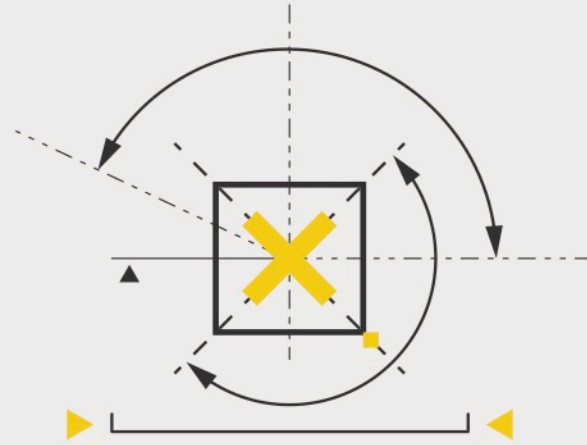
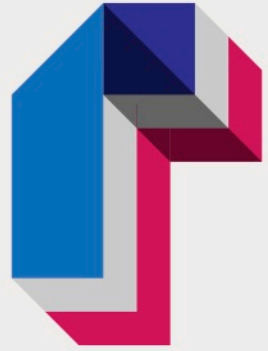

MANUFACTURING EXECUTION SYSTEM

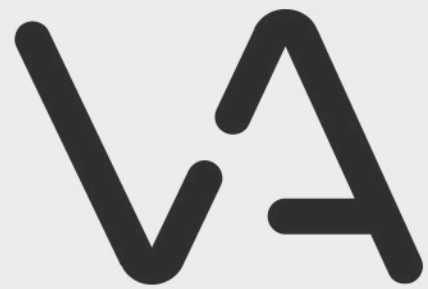
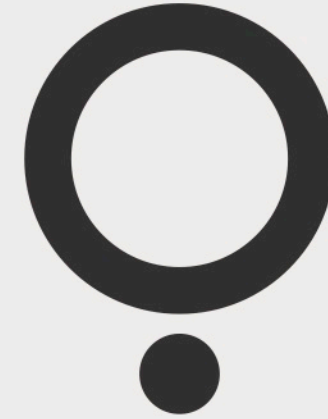



 ECHO

 CHO

 CHO 

 CHO 

 CHO

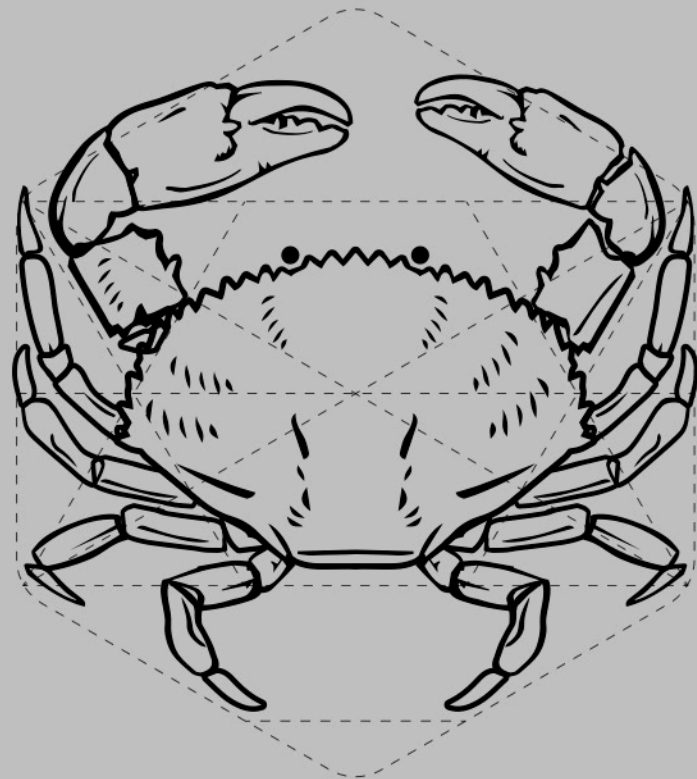

CADMAKERS ANNUAL VOLUNTEER DAY

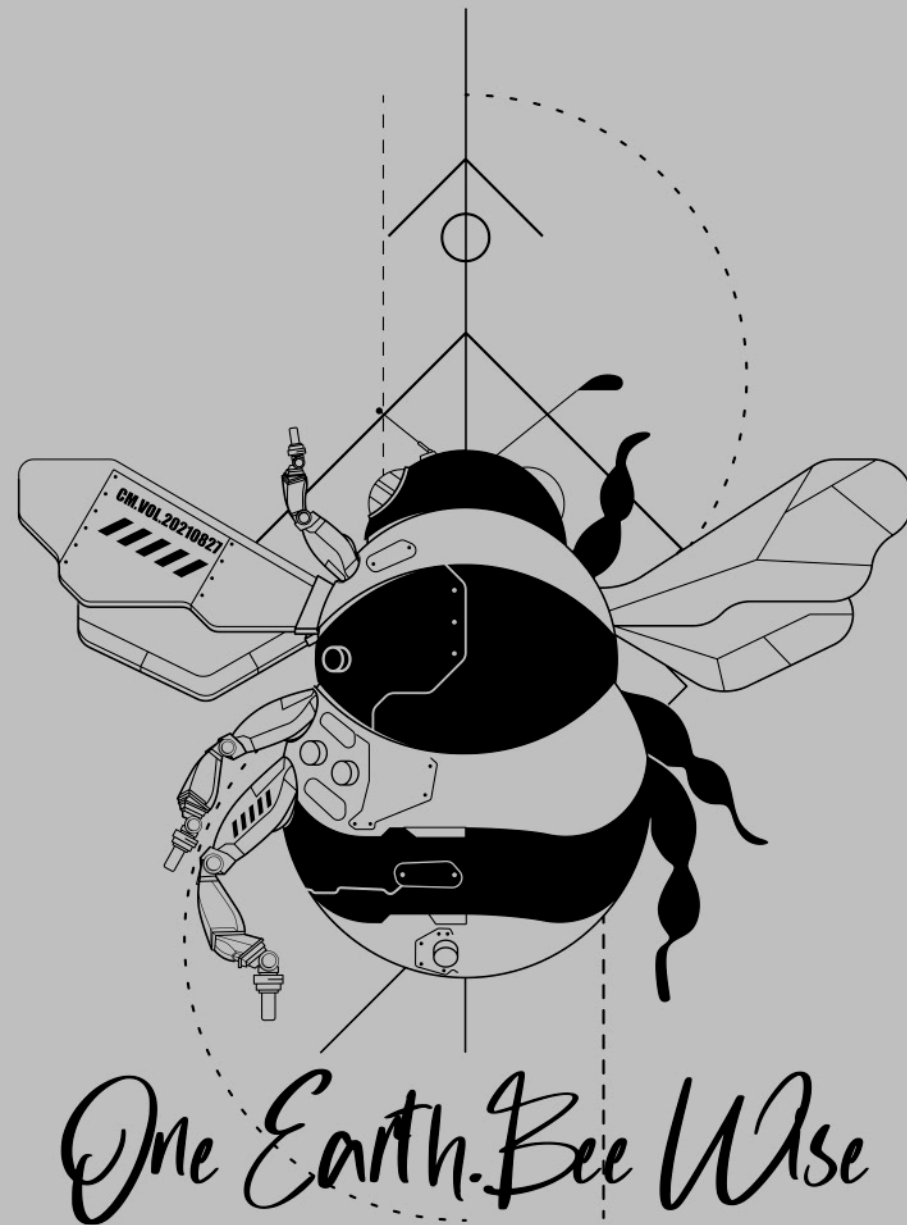

*One Earth. Bee Wise*

CADMAKERS ANNUAL VOLUNTEER DAY

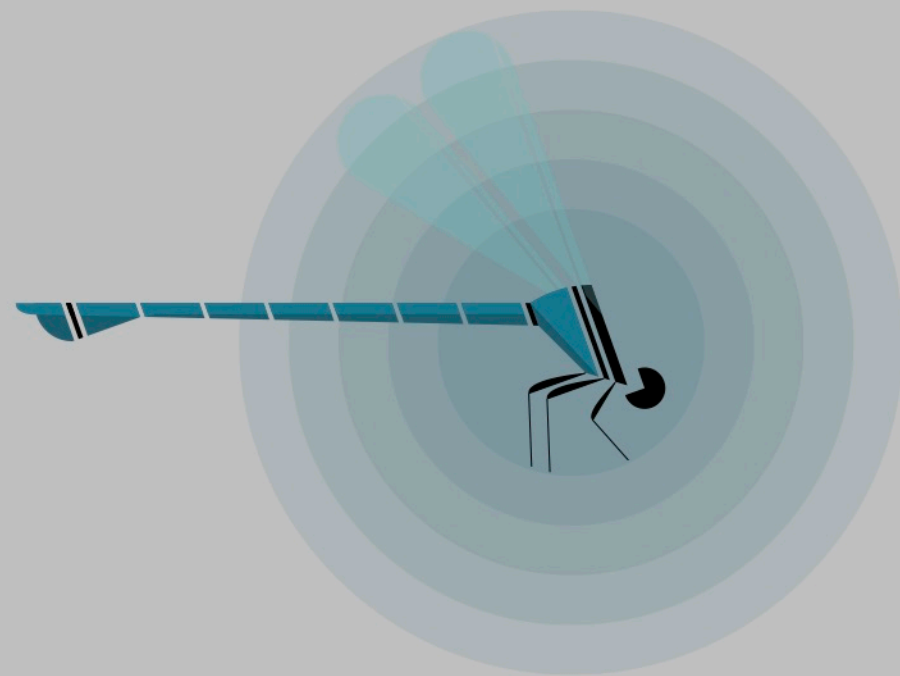
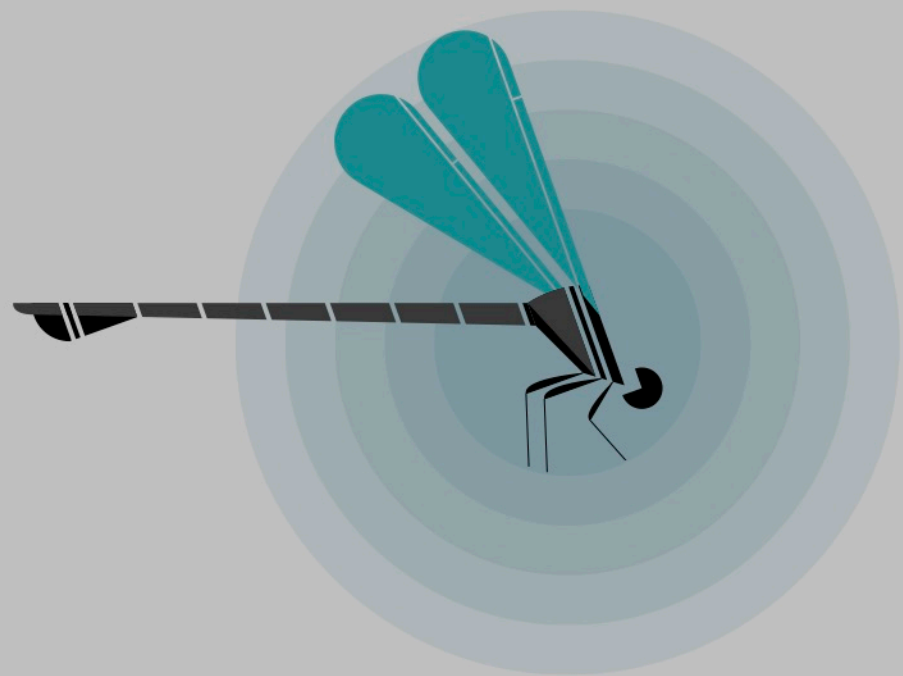
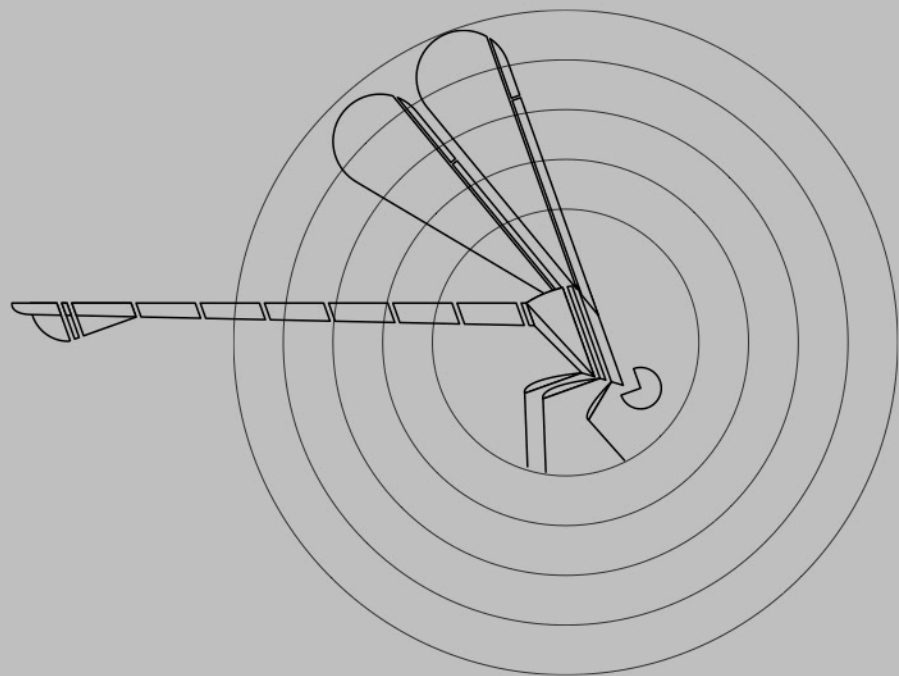















# ANI AFRICAN ART

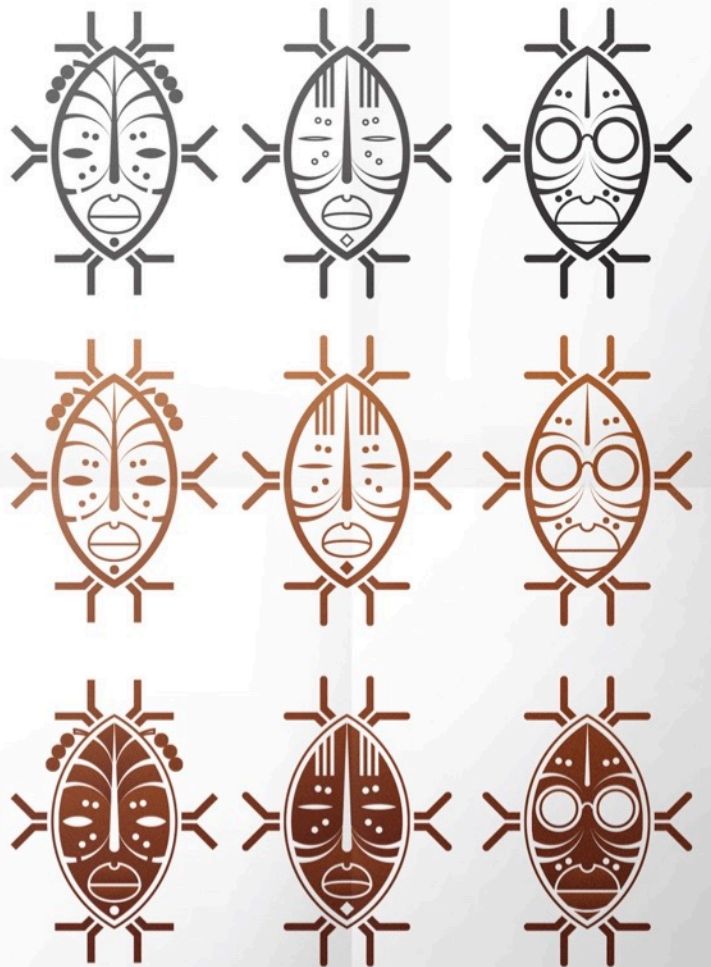

**NSIBIDI** WRITING OF THE  
 EAGHAM PEOPLE  
 EXAMPLES OF A FEW TYPICAL NSIBIDI SYMBOIS  
 AND THEIR MANY SUBTLE VARIATIONS

X(=)X HATRED, DIVORCE  
 LOVE, UNITY

X X + + \* (wheel) (circle)  
 WORD, SPEECH, MEETING, CONGRESS

φ □ □ □ □ □  
 MIRROR, REFLECTION

Y Z Q P o e e f i i g o d r  
 TABLE SET FOR DRINK AND MEAT

— — — — —  
 TREK, JOURNEY, VOYAGE, TRACKS

☾ ☰ ☷ ☱ ☲ ☳ ☴ ☵ ☶ ☷  
 (SIBIDI) (SIBIDI) (SIBIDI) (SIBIDI) (SIBIDI) (SIBIDI) (SIBIDI) (SIBIDI) (SIBIDI) (SIBIDI)  
 THORN | DRINKER | SKIN | FRIEND | JUPON | POINT | INHALER

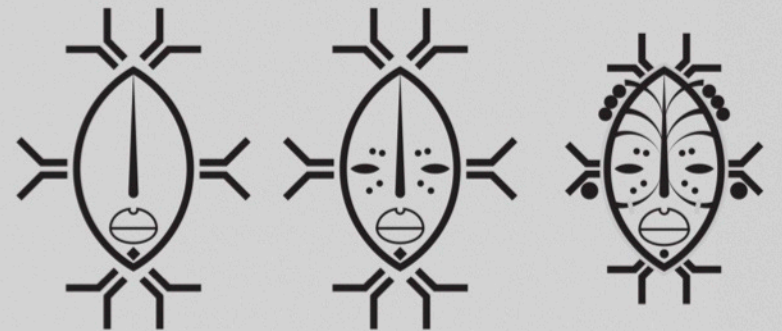
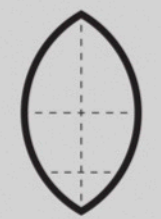
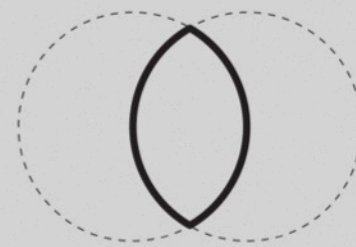



**GHO**

Lorem ipsum dolor sit amet,

Lorem ipsum dolor sit amet, consectetur adipiscing elit. Donec orci purus, luctus vitae dignissim eu, iaculis sed purus. Vivamus faucibus, ipsum nec aliquet viverra, leo mauris condimentum ligula, sit amet sagittis enim ligula quis arcu. Nam egestas tortor id nisi porttitor mattis. In tortor ante, ultricies in suscipit a, tempus non massa. Vivamus et auctor mi. Fusce vel massa nulla. Phasellus nec eros mauris, et scelerisque orci. Donec malesuada orci vitae nulla accumsan porta a id massa. Quisque accumsan iaculis magna sit amet fringilla. Maecenas consequat, magna eget tincidunt semper, odio nibh rutrum mi, id feugiat ante nisi eu risus. Vestibulum nunc orci, rhoncus a placerat in, ultricies in mi. Cras mattis varius eros, vel fringilla nisi suscipit eget.

Quisque scelerisque sagittis nulla at porttitor. Mauris a justo et tellus interdum tristique. Sed id augue vitae urna euismod commodo aliquet a quam. Pellentesque arcu velit, cursus et malesuada ut, consequat et diam. Nullam erat sem, rhoncus id ullamcorper vitae, rhoncus et arcu. In ultricies ultricies nulla, ut rutrum nisi iaculis at. Donec eu magna a metus ornare faucibus. Fusce aliquet faucibus ultricies. Morbi semper, est id tincidunt gravida, sem arcu adipiscing lacus, ac bibendum nulla leo eu purus. Quisque nec diam sed risus consectetur a coumsan quis quis nibh. Vestibulum id purus lorem.

Vivamus vehicula accumsan lacinia. Aliquam erat volutpat. Pellentesque consequat venenatis velit non gravida. Etiam et sem et nulla congue aliquam sed eget augue. Nulla facilisi. Pellentesque habitant morbi tristique senectus et netus et malesuada fames ac turpis egestas. Nulla a elit at sem iaculis congue. Nullam mollis tristique lobortis.

Echo Light&Sound T: (02) 627 7077 - F: (02) 627 1190 - POBox 39392, Abu Dhabi, United Arab Emirates

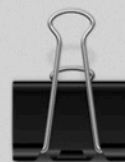
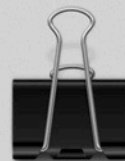
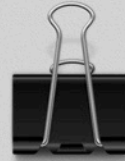
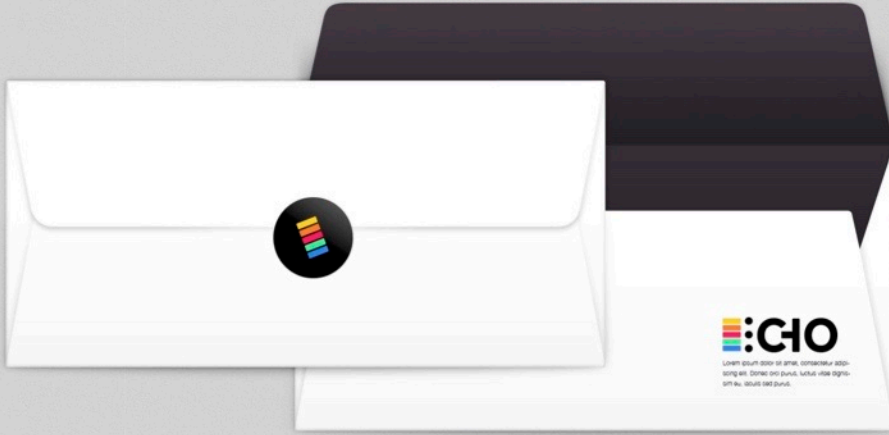
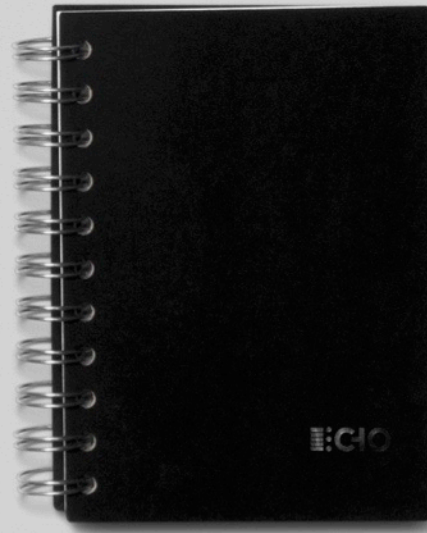

**GHO** **Fax**  
COVER SHEET

DATE: January 01, 2007  
TO: Mr. Johnson FAX: (123) 456-7890

Number of pages including cover sheet: 5

SUBJECT: Lorem Ipsum Dolor Sit Ame

MESSAGE:

Lorem ipsum dolor sit amet, consectetur adipiscing elit. Nam eget enim a justo maximus feugiat vitae eget turpis. Fusce nec pretium quam, vel placerat odio. Sed eleifend fringilla viverra. Sed eget sollicitudin nibh, nec dignissim augue. Curabitur vitae tempus tortor. Donec sollicitudin ligula erat, sit amet volutpat elit dapibus vitae. Sed placerat aliquam elit sit amet volutpat.

Please verify receipt of document by calling the above telephone number.

**DISCLAIMER:**  
The information contained in this facsimile message is intended for the sole confidential use of the designated recipients and may contain confidential information. If you have received this information in error, any review, dissemination, distribution or copying of this information is strictly prohibited. If you have received this communication in error, please notify me immediately by telephone. Thank you.  
If you do not receive all pages, please call at (02) 627 7077.

Echo Light&Sound T: (02) 627 7077 - F: (02) 627 1190 - POBox 39392, Abu Dhabi, United Arab Emirates

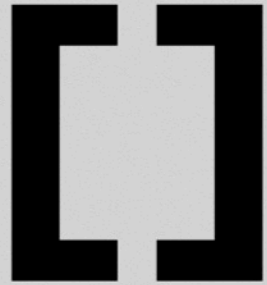

**BRACKET®**

**LIFESTYLE PRODUCTS**

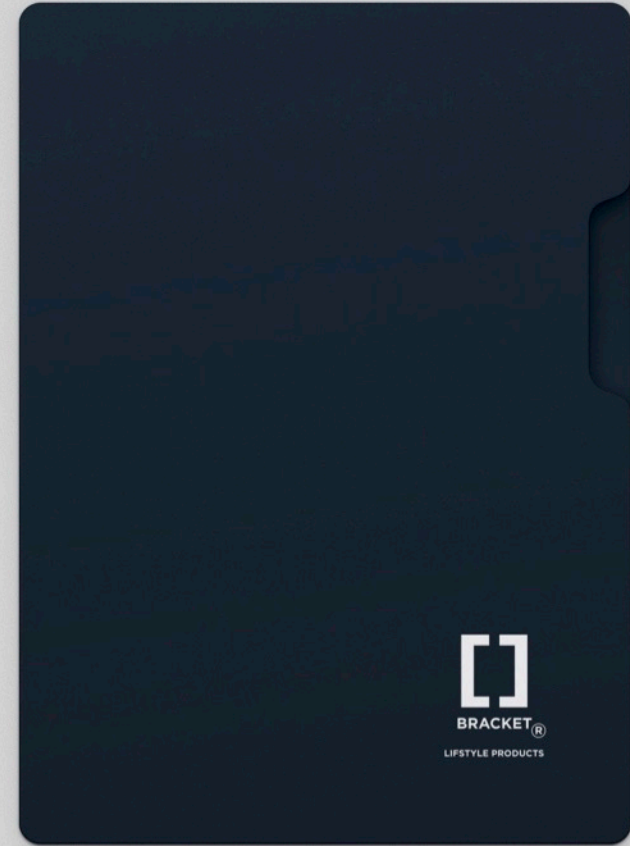
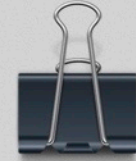
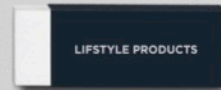
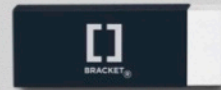



**NEUENOTION DESIGN**  
neuenotion.com

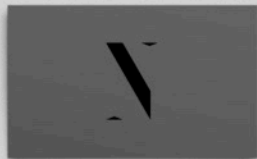



The Expo2020 Dubai logo has been inspired from the rich traditional Arabic architecture. While a form of mathematical and geometrical shapes, it is simple in design. The logo is based on the traditional pattern of contemporary design. The rich traditional architecture used as the basis for this design is timeless and always in hearts and memories of Arab nations, if not all around the world. The typography in this design is self expressive and clear. The 'PO' in the word 'EXPO' been used as '20' as well to show partnership and cooperation, as well as functionality, flexibility and innovation in the new Expo2020 Dubai. The finely designed details of the logo, corners and edges represent luxurious lifestyle of Dubai and colors illustrate the energy and life in this region. The continuity in forms of letters stand for connectivity. The logo can be used easily on any print or digital screen in any size from a 3.5"x2" card to a large street poster.



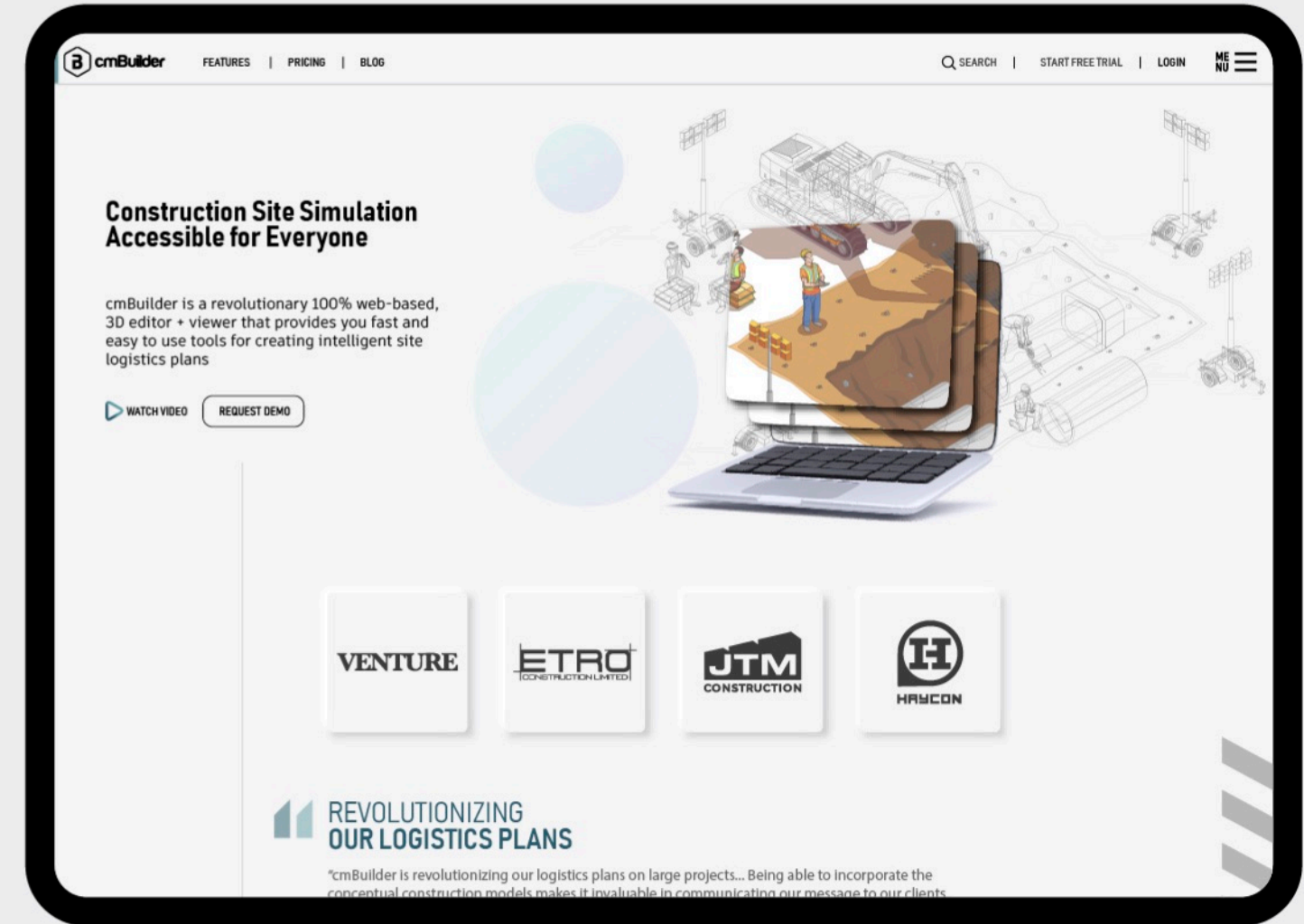
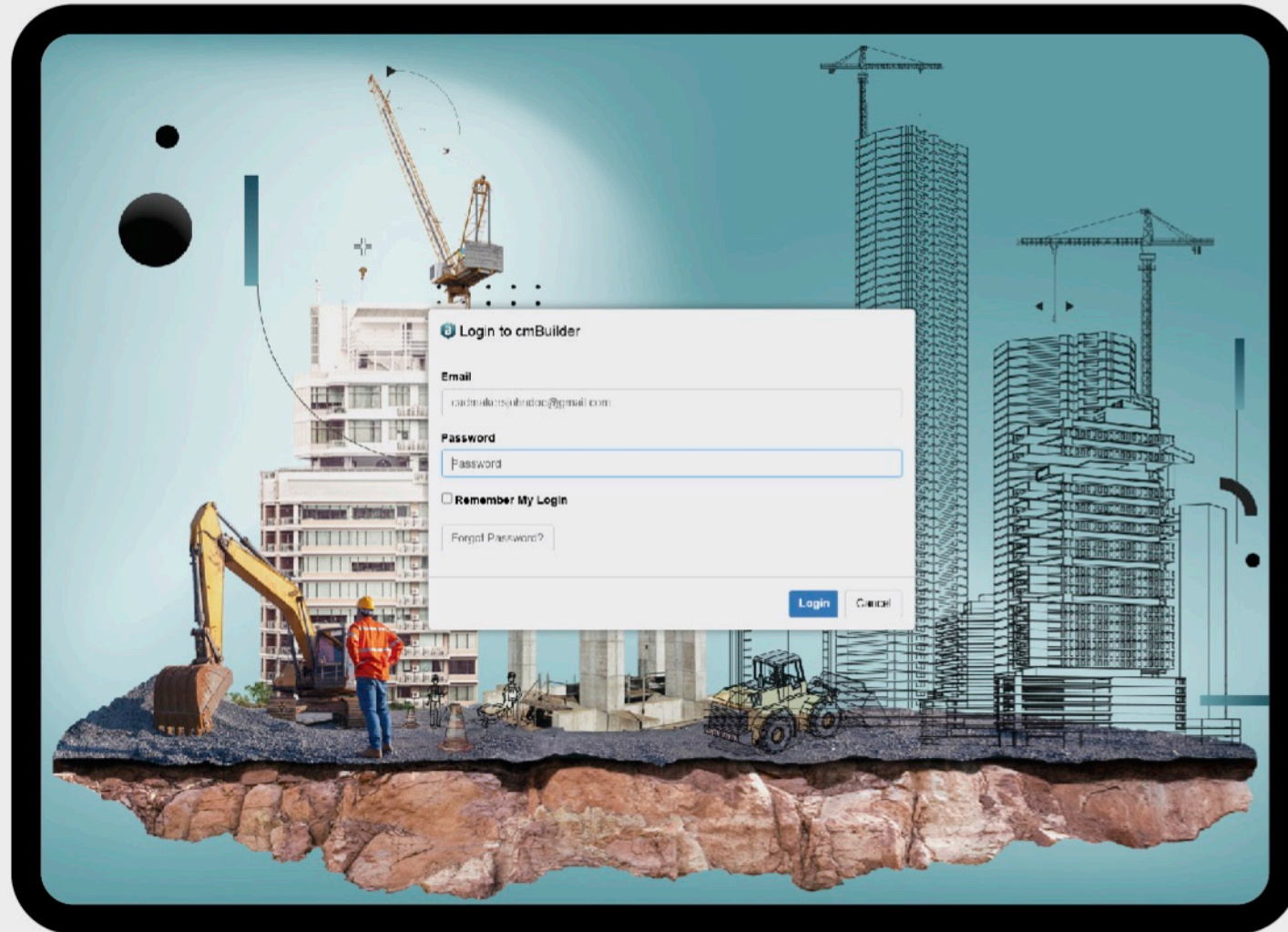
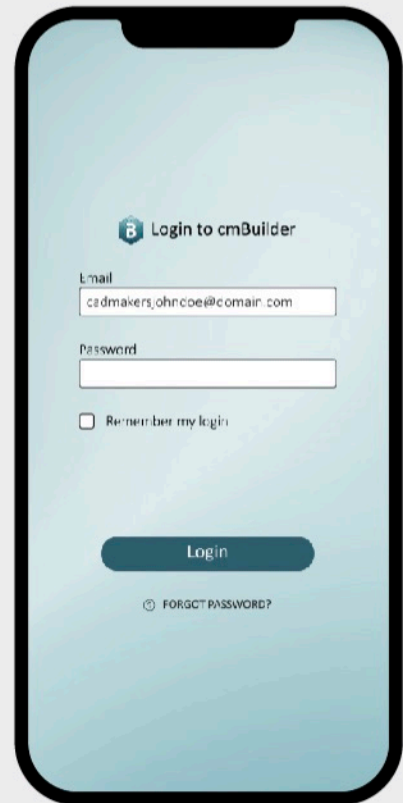



**cmBuilder.io**

**LIVE PRODUCT DEMO - cmBuilder.io**

**15**  
DECEMBER  
**2022**  
7AM PST



**cmBuilder.io**

VIRTUAL PANEL DISCUSSION  
THU SEP 15TH 2022  
7:30AM PST / 4:30PM GMT  
TEAMS LIVE EVENT

FEATURED CUSTOMERS  
**Implenia** **Jacobs** **Balfour Beatty**

**MORNING COFFEE & AFTERNOON TEA: A ROUNDTABLE DISCUSSION ON THE LATEST IN CONTECH INNOVATIONS**

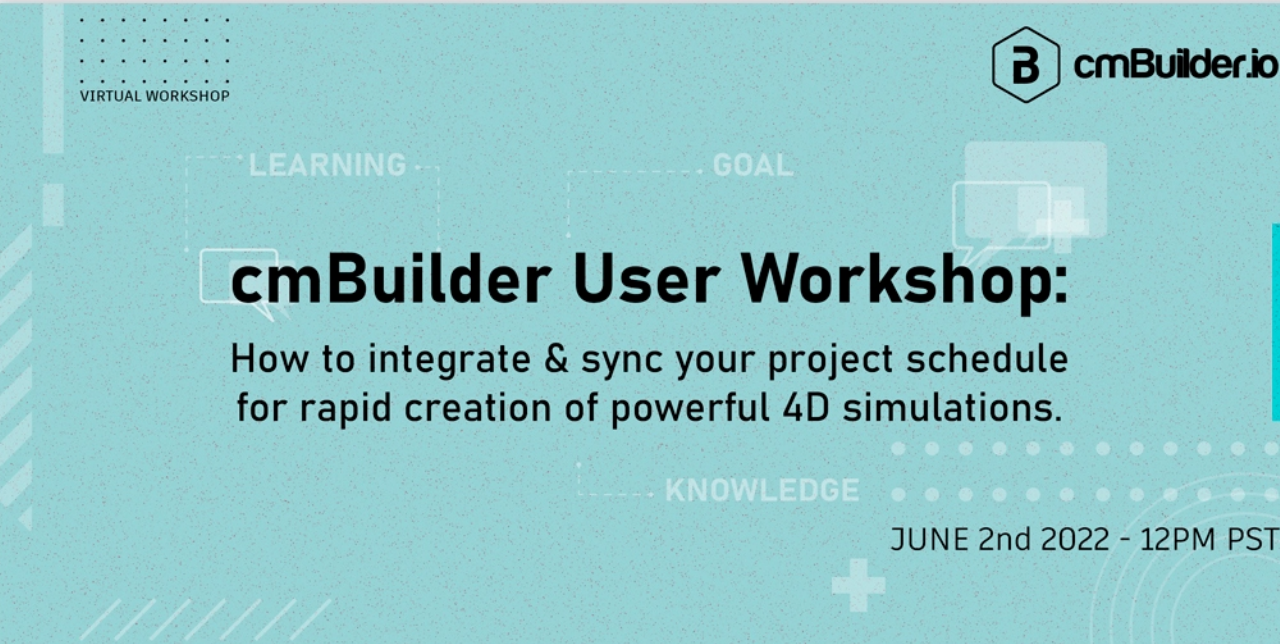

**cmBuilder.io**

VIRTUAL WORKSHOP

LEARNING GOAL

**cmBuilder User Workshop:**  
How to integrate & sync your project schedule for rapid creation of powerful 4D simulations.

KNOWLEDGE

JUNE 2nd 2022 - 12PM PST



**cmBuilder.io**

VIRTUAL WORKSHOP

**cmBuilder User Workshop:**  
THE LATEST AND GREATEST: GUIDE TO NEW CMBUILDER FEATURES FOR SUCCESS

SEP 1st 2022 - 12PM PST

**REGISTER NOW**

VIRTUAL WORKSHOP



**cmBuilder User Workshop:**  
FAST AND FURIOUS 4D ON THE CLOUD - THE LATEST AND GREATEST UPDATES IN CMBUILDER

OCT 20th 2022 - 12PM PST

The poster features a background of a construction site with scaffolding on the left. Overlaid on this are abstract geometric shapes in shades of teal, red, and grey, along with a large speech bubble containing three white dots. The cmBuilder.io logo is in the top right corner.

VIRTUAL WORKSHOP



**cmBuilder User Workshop**  
THE cmBuilder BUTTERFLY EFFECT: SMALL ACTIONS THAT MAKE GREAT IMPACT!

DEC 1st 2022 - 12PM PST

The poster features a background of a construction site with cranes. A large, stylized blue butterfly is the central focus, with a large 'B' logo integrated into its body. The cmBuilder.io logo is in the top right corner.

VIRTUAL WORKSHOP



**cmBuilder User Workshop:**  
cmBuuuuuilders, Roll out! - Transforming your 3D site logistics plan into a well oiled machine

JAN 31st 2023 - 12PM PST

The poster features a background of a construction site with cranes and a large red 'X' over a circular area. The cmBuilder.io logo is in the top right corner.

VIRTUAL WORKSHOP



**cmBuilder User Workshop:**  
Every resource, every site, all at once...with cmBuilder

MAR 29th 2023 - 12PM PST

The poster features a dark background with a large, glowing 3D point cloud of a construction site. The words 'LEARNING' and 'KNOWLEDGE' are visible in the background. The cmBuilder.io logo is in the top right corner.



VIRTUAL WORKSHOP



# cmBuilder User Workshop:

cmBuilder: A New Hope  
(For Better Site Logistics Planning)

MAY 4th 2023 - 12PM PST

VIRTUAL WORKSHOP



# cmBuilder User Workshop

JUN 30th 2023 - 10AM PST

Site Plans - Create Project (cmBuilder)

cmBuilder VIRTUAL EVENT

## Learn what the buzz is all about: Live cmBuilder.io Product Demo

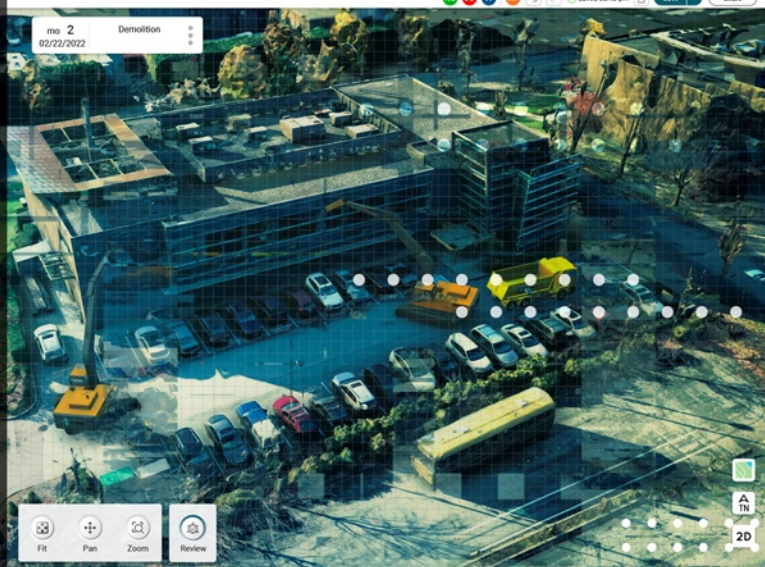

JUN 8th 2023 - 3PM PST



VIRTUAL PANEL DISCUSSION

TUE FEB 28TH 2023  
12PM PST  
WED MAR 1ST, 2023  
9AM NZST

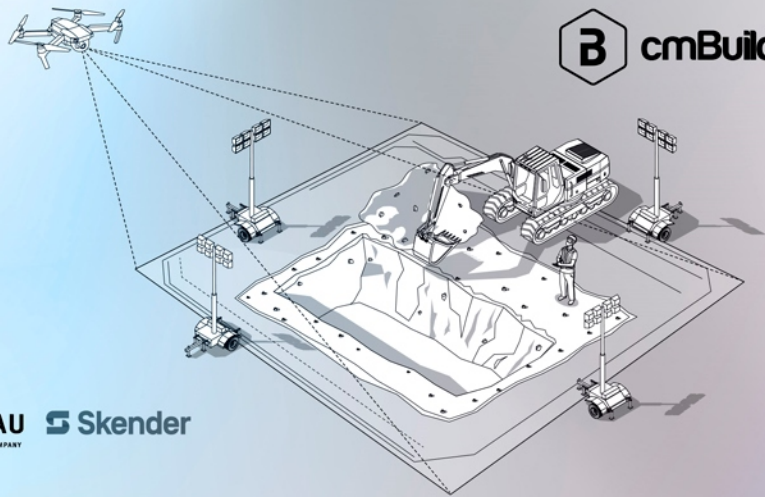
FEATURED CUSTOMERS

## CONSTRUCTION TAKES FLIGHT ROUNDTABLE: EXPERTS DISCUSS THE RISE OF DRONES IN THE CONSTRUCTION INDUSTRY



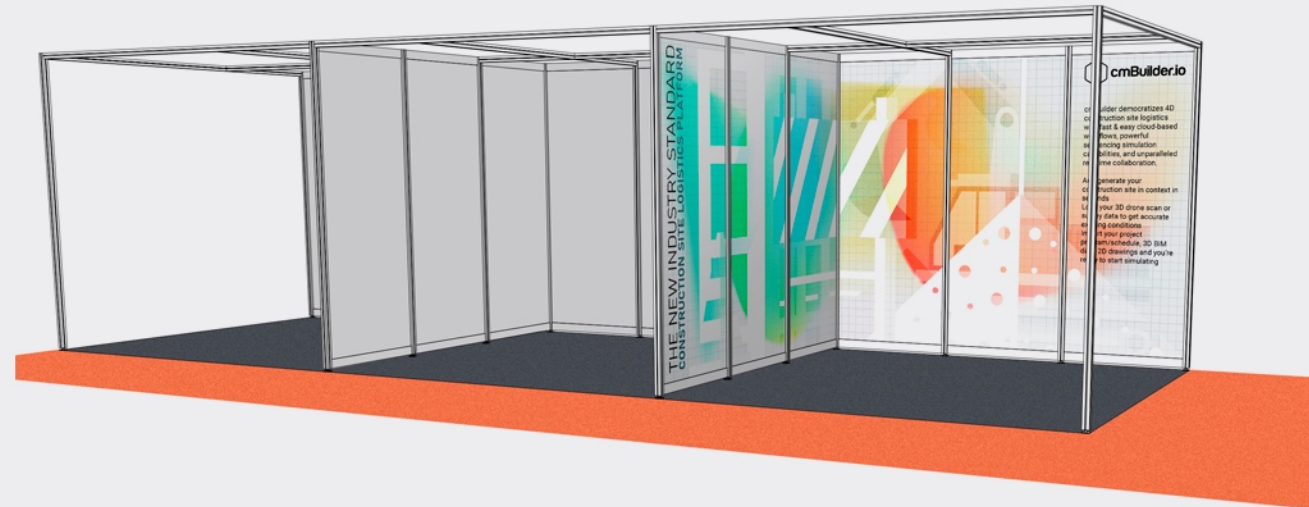

Booth Backdrop Design

while working at CadMakers

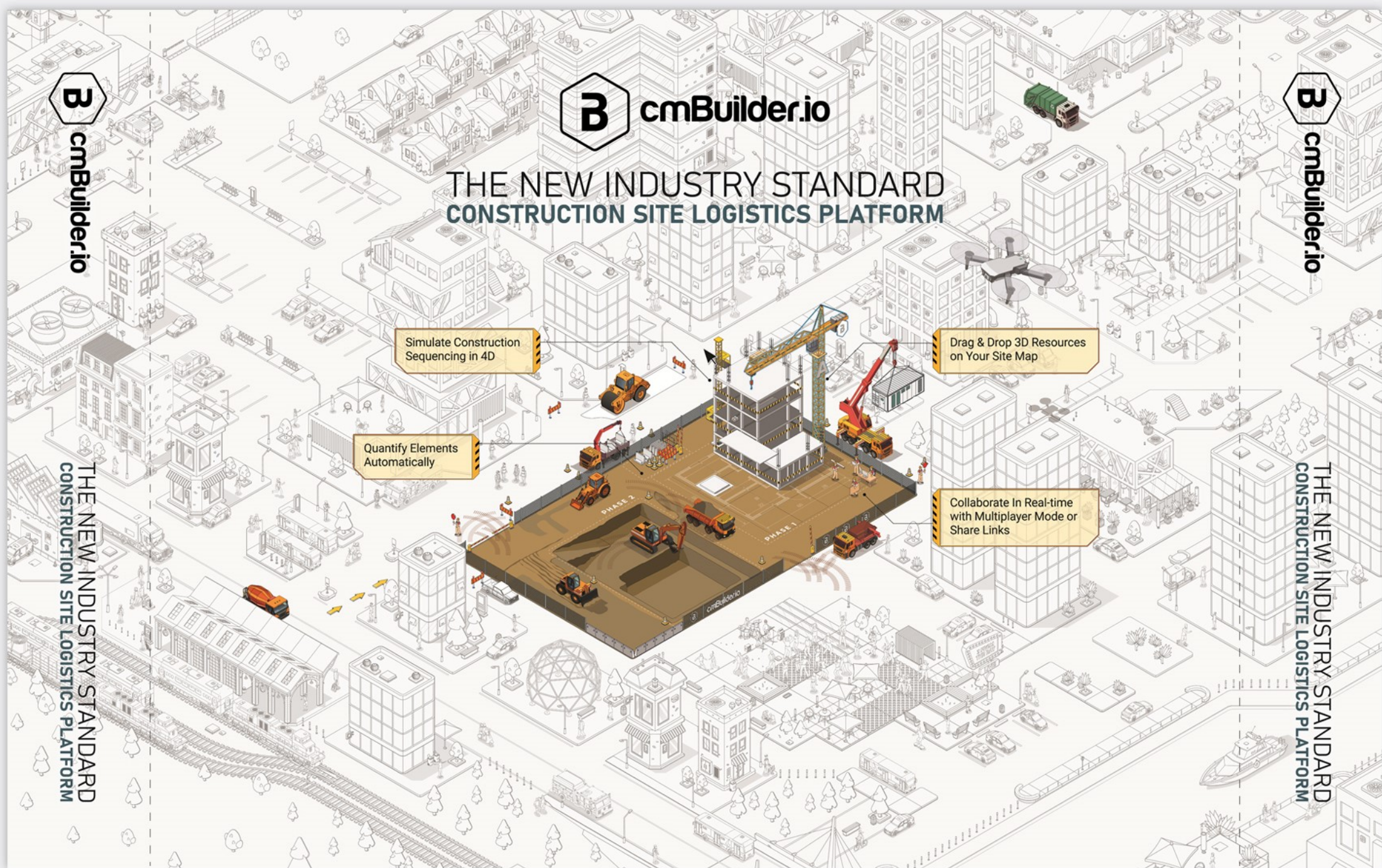

**cmBuilder.io**

3D NESTING: -

**cmBuilder.io**

It's that easy...

**cmBuilder.io**

**Schedule Integration**

**cmBuilder.io**

Saving time and money  
with real-time collaboration on the cloud

Share Links, Not Files  
**Collaborate Better**



**SITE LOGISTICS PLANNING**



WORK EFFECTIVELY AND EFFICIENTLY WITH  
**TOWER CRANES IN 4D SIMULATIONS**

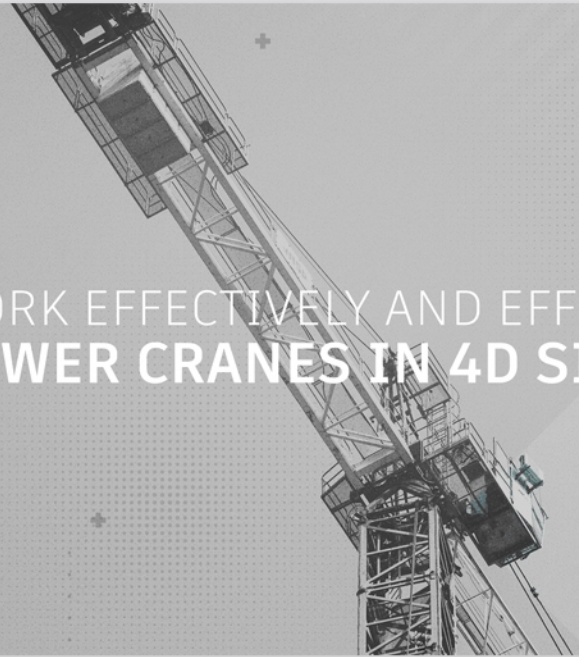

**VISUAL  
GRAPH**

INTRODUCTION TO LOGIC  
GRAPH RESOURCE ANIMATION

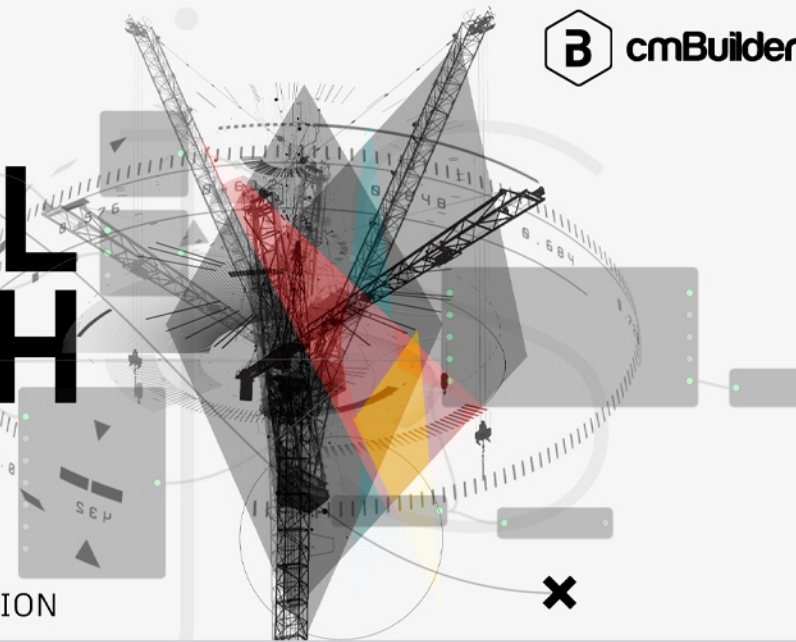

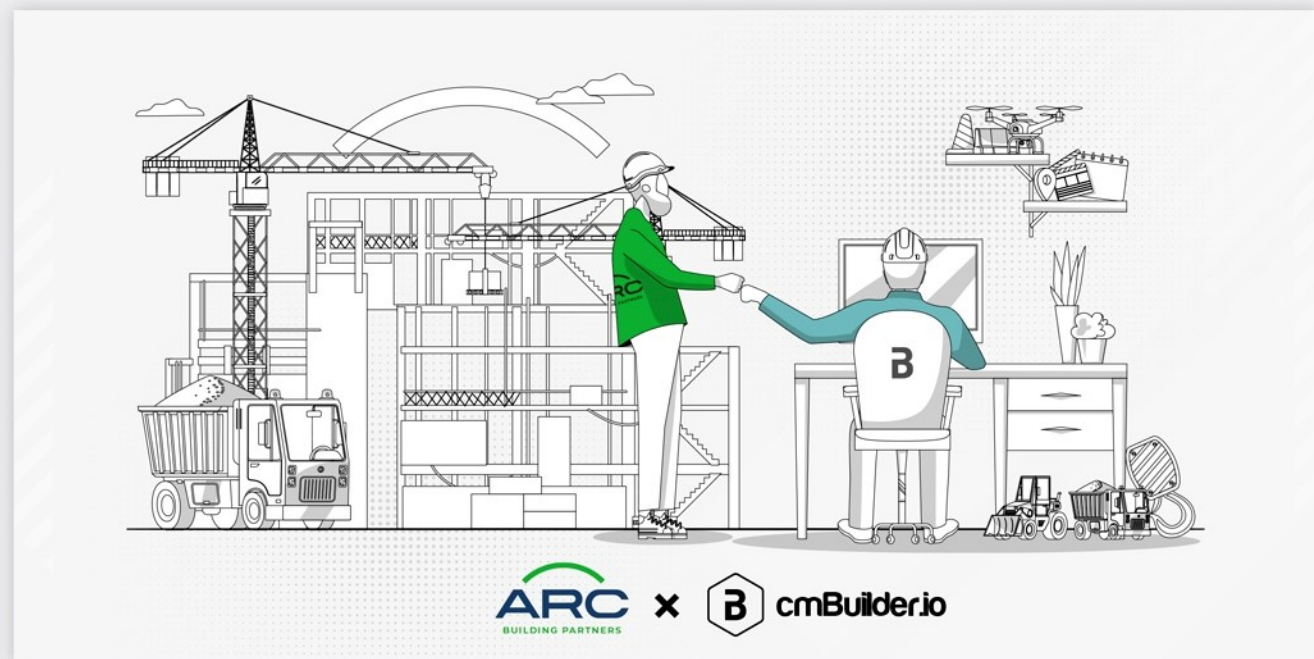
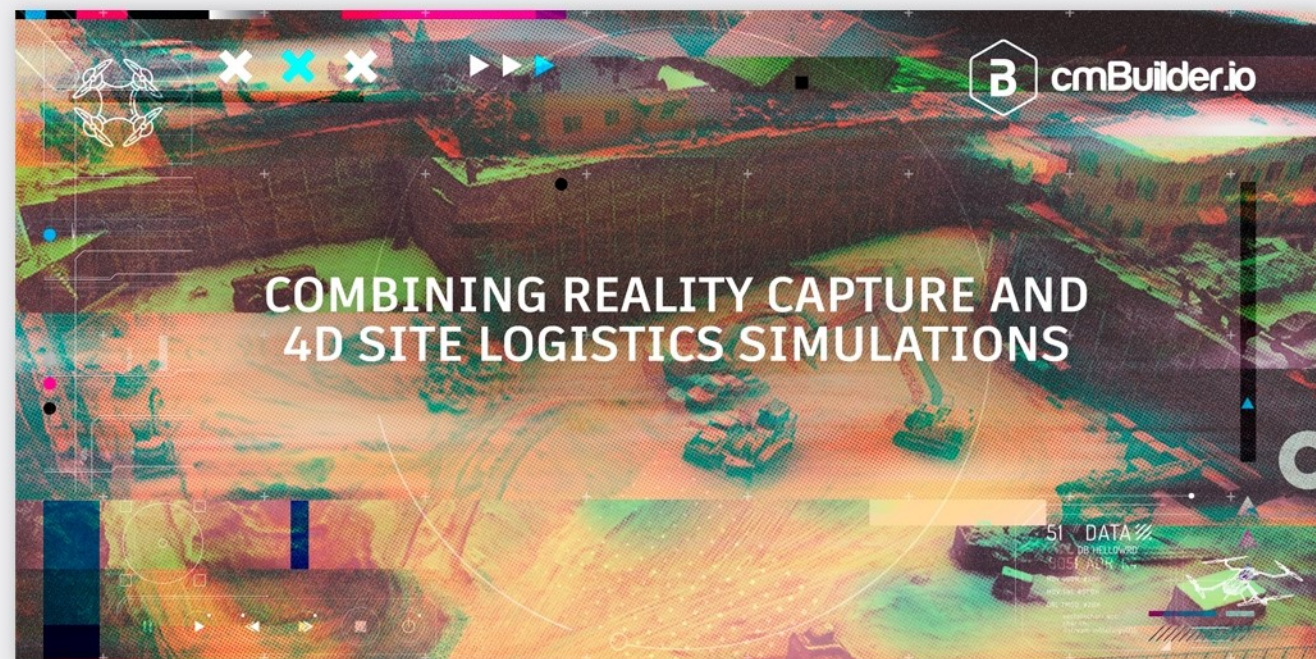

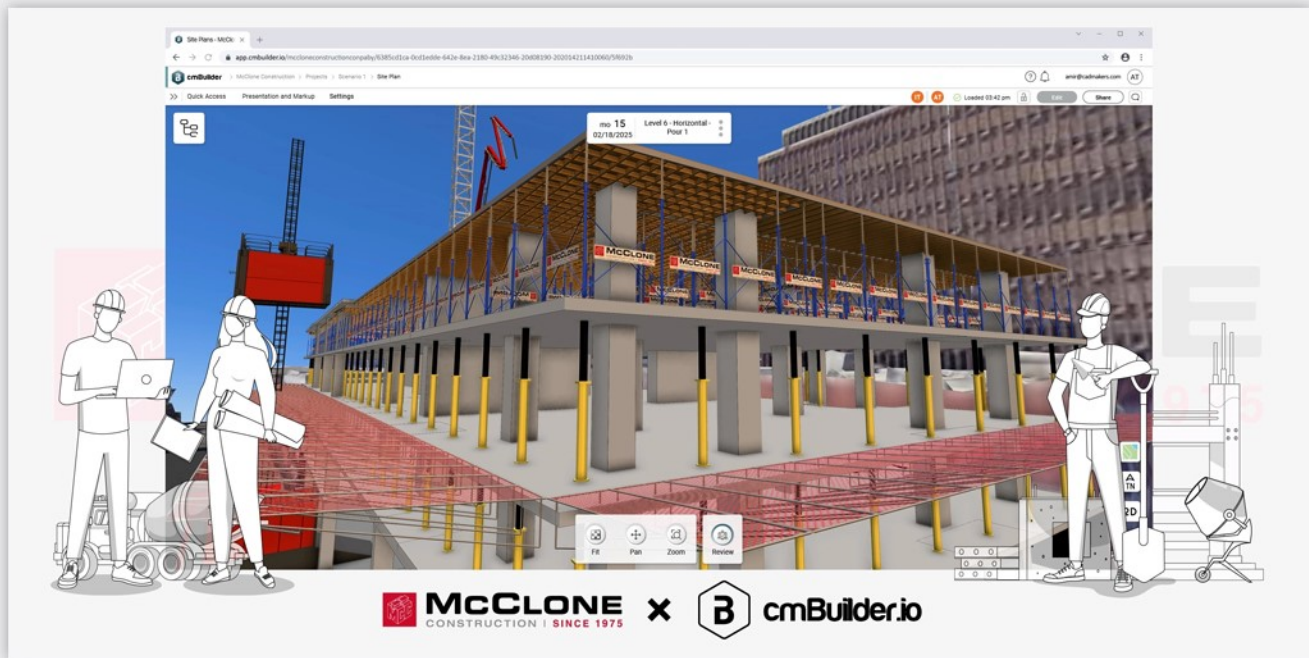
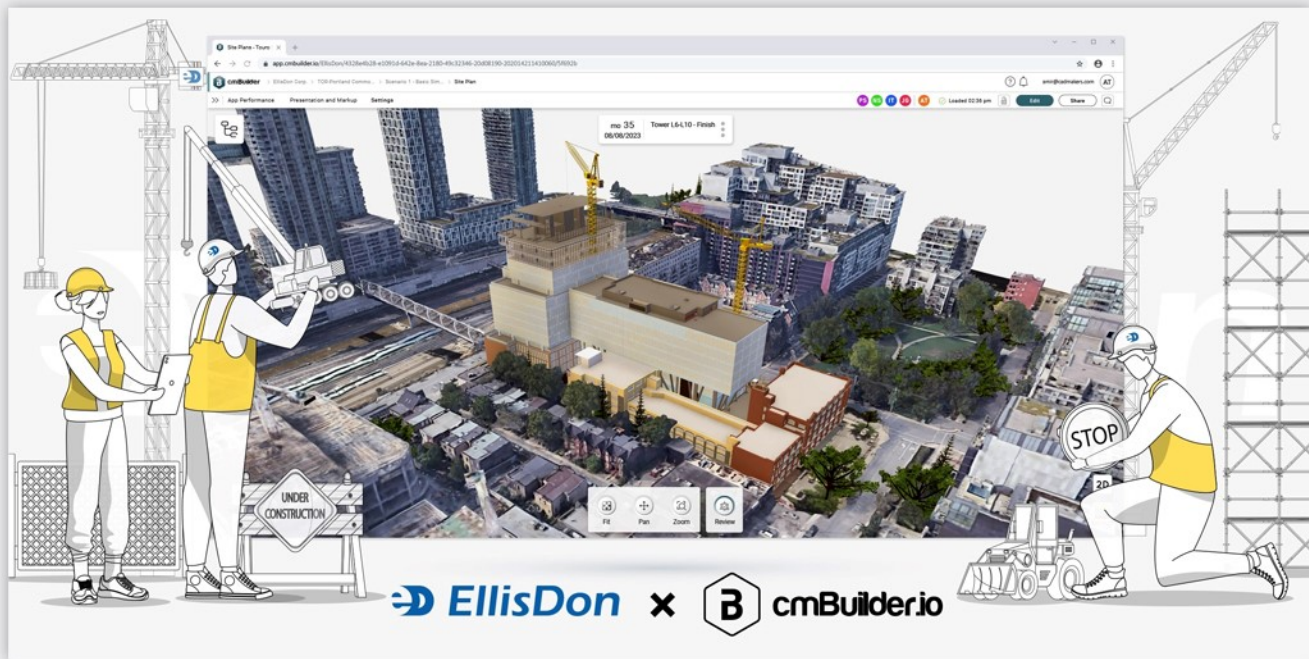

VIRTUAL WORKSHOP

**cmBUILDER USER WORKSHOP**

YIPPEE KI-YAY cmBUILDERS!

NOV 28th 2023 - 12PM PT



VIRTUAL EVENT

**cmBuilder Open Demo**

APAC

DEC 14th 2023 - 5:00 PM PT



VIRTUAL WORKSHOP

*cmBuilder User Workshop*

How The cmGrinch Stole 2D



DEC 21 2023 - 12PM PT





VIRTUAL WORKSHOP

**THE LORD OF CM BUILDER: THE FELLOWSHIP OF 4D PLANNING**

JAN 23, 2023 - 12PM PT



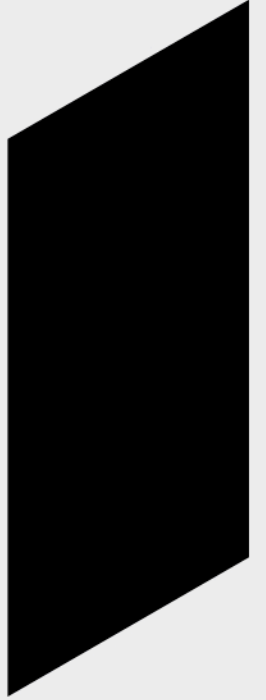
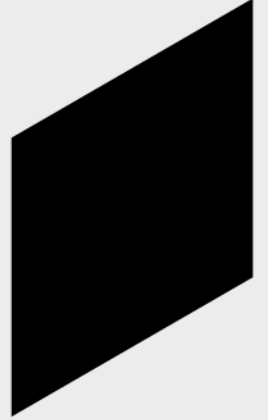
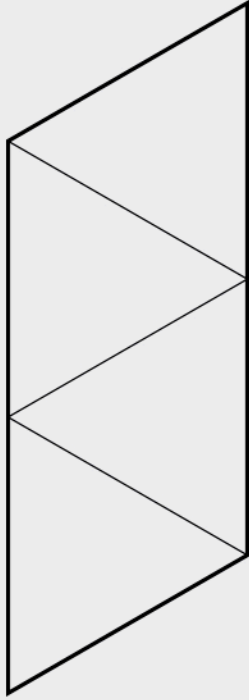
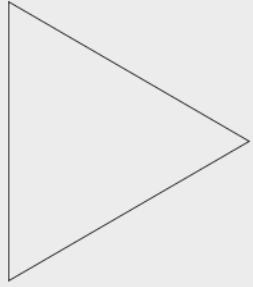



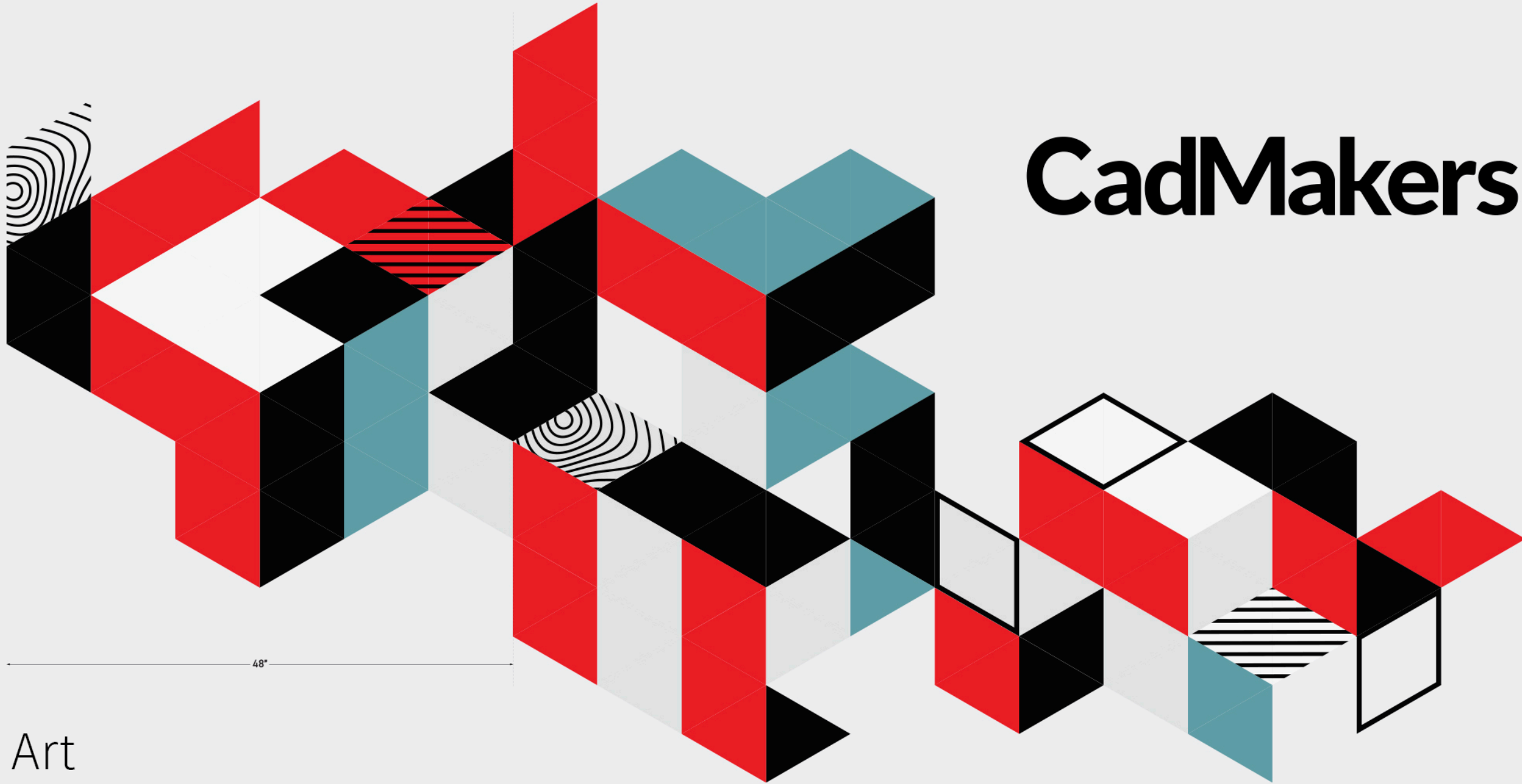

# Office Wall Art

*while working at CadMakers*



# CadMakers

Office Wall Art

*while working at CadMakers*



CadMakers



# Q Quantic Design

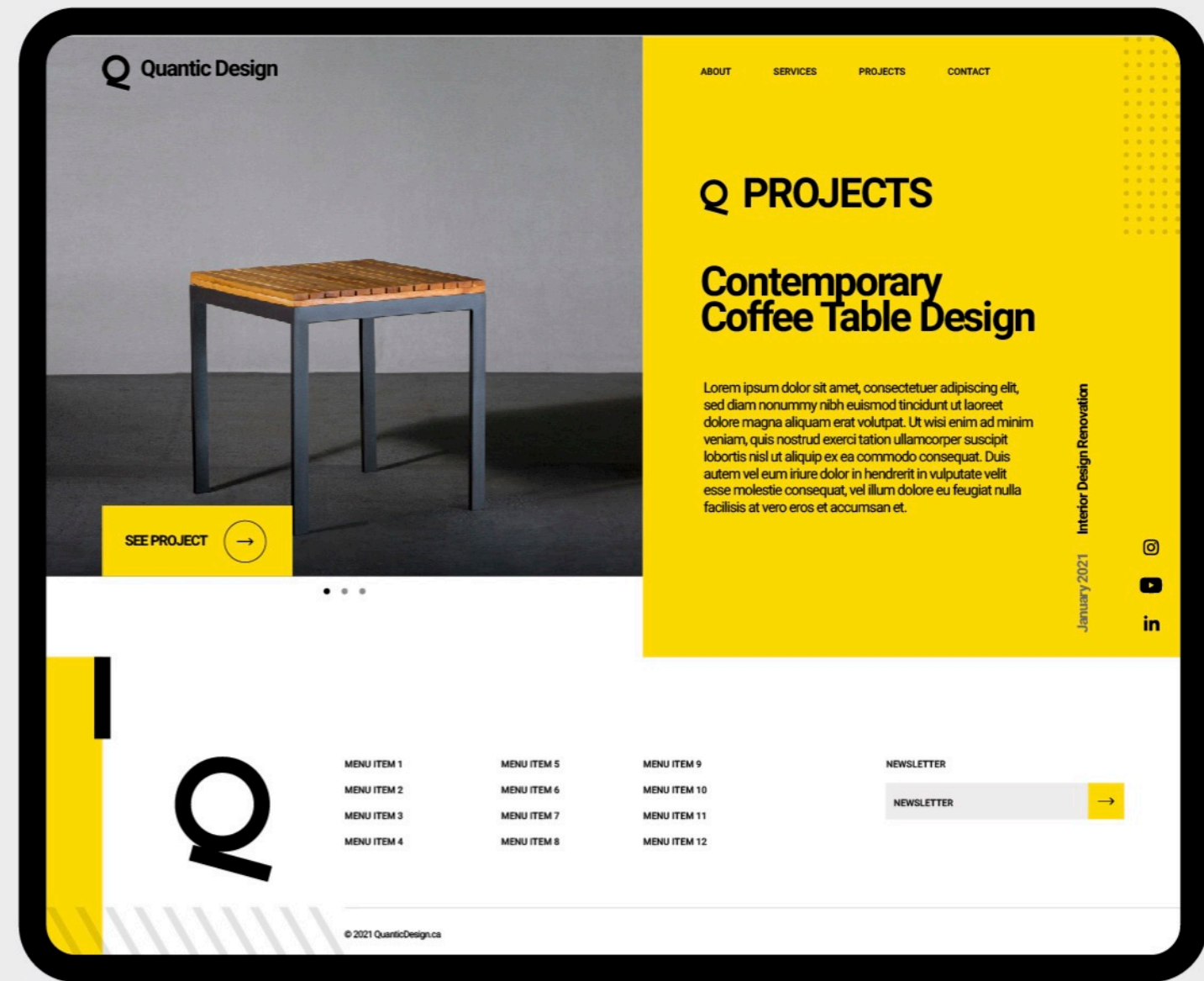

AMIR TALACHIAN